

Digital Counter & Timer

GF4

INSTRUCTION MANUAL

Thank you for purchasing HANYOUNG product.
Please check whether the product is the exactly same as you ordered.
Before using the product, please read this instruction manual carefully.
Please keep this manual where you can view at any time

HEAD OFFICE

HANYOUNGNUX CO.,LTD

1381-3, Juan-Dong, Nam-Gu Incheon, Korea.
TEL:(82-32)876-4697
FAX:(82-32)876-4696
http://www.hynux.net

INDONESIA
FACTORY

PT. HANYOUNG ELECTRONIC INDONESIA

Jl. cempaka blok F16, No.02 Delta Silicon II
Cikarang Bekasi Indonesia
TEL : 62-21-8911-8120~4
FAX : 62-21-8911-8126

HANYOUNG NUX



Safety information

Before using the product, please read the safety information thoroughly and use it properly.
Alerts declared in the manual are classified to Danger, Warning and Caution by their criticality

	DANGER	DANGER indicates an imminently hazardous situation which, if not avoided, will result in death or serious injury
	WARNING	WARNING indicates a potentially hazardous situation which, if not avoided, could result in death or serious injury
	CAUTION	CAUTION indicates a potentially hazardous situation which, if not avoided, may result in minor or moderate injury

DANGER

Do not touch or contact the input/output terminals because it may cause electric shock.

WARNING

- If the user use the product with methods other than specified by the manufacturer, there may be bodily injuries or property damages.
- If there is a possibility of an accident caused by errors or malfunctions of this product, install external protection circuit to prevent the accident.
- Since this product does not have the power switch or a fuse, please install those separately on the outside. (Fuse rating: 250V 0.5A)
- To prevent electric shock or equipment failure, please do not turn on the power until completing wiring.
- Never disassemble, modify, or repair the product. There is a possibility of a malfunction, an electric shock, or a risk of fire.
- Please turn off the power when mounting/dismounting of the product. This is a cause of an electric shock, a malfunction, or failure.
- To prevent damage or failure of this product, please supply the rated power voltage.
- Since this is not explosion-proof structure, please do not use in a place where combustible or explosive gas is around.
- Since there is a possibility of an electric shock, please use the product as mounted on a panel while the power is being supplied.

CAUTION

- The contents of the instruction manual are subjective to change without prior notice.
- Please make sure that the specification is the same as what you have ordered.
- Please make sure that the product is not damaged during shipping.
- Please use this product in a place where corrosive gas (such as harmful gas, ammonia, etc.) and flammable gas do not occur.
- Please use this product in a place where there is no direct vibration and a large physical impact to the product.
- Please use this product in a place where there is no water, oil, chemicals, steam, dust, salt, iron or others.
- Please do not wipe this product with organic solvents such as alcohol, benzene and others. (Please use mild detergent)
- Please avoid places where excessive amounts of inductive interference and electrostatic and magnetic noise occur.
- Please avoid places where heat accumulation occurs due to direct sunlight or radiant heat.
- Please use this product in a place where the elevation is below 2,000 m.
- Please make sure to inspect the product if exposed to water since there is a possibility of an electric leakage or a risk of fire.
- If there is a lot of noise from the power line, installing an insulated transformer or a noise filter is recommended. The noise filter should be grounded on the panel and the lead wire between the output of the noise filter and the power terminal of the instrument should be as short as possible.
- It is effective against noise if making the power lines of the product the twisted pair wiring.
- Please do not connect anything to the unused terminals.
- Please connect wires properly after making sure the polarity of terminal.
- Install a switch or circuit breaker that allows the operator to immediately turn OFF the power, and label it to clearly indicate its function.
- Please install a switch or break near the operator to facilitate its operation.
- Write down on a label that the operation of circuit breaker or switch disconnects the power since the devise is installed.
- In order to use this product properly and safely, we recommend periodic maintenance.
- Some parts of this product have limited expected life span and aged deterioration.
- The warranty of this product (including accessories) is 1 year only when it is used for the purpose it was intended under normal condition.
- When the power is being supplied there should be a preparation time for the contact output. Please use a delay relay together when it is used as a signal on the outside of interlock circuit or others.

Features

- Operates all functions by switches at front (Multi-range input/Free scale)
- Counting speed 5 kcps selectable
- ON-DELAY/OFF-DELAY selectable
- Position of a decimal point is movable (in counter)
- Wide ranges of power supply (100 - 240 V a.c)
- Semi-permanent backup power for memory protection
- 14 input / 16 output mode
- Relay output and transistor output

Suffix code

Model	Code	Description
GF4 -	<input type="checkbox"/> <input type="checkbox"/> <input type="checkbox"/> <input type="checkbox"/>	Digital counter & timer 48(W) x 96(H) mm
Type	P	Preset counter
	T	Total counter
Displayable digit	4	4 digits (9999)
Setting stage	1	1 stage setting (preset counter)
	0	None (total counter)
Terminal structure	N	Terminal
	S	8 pin structure (suitable for 8 pin socket)

Specification

Model	Total	GF4-T40N
	Preset	GF4-P41N / GF4-P41S
Power supply voltage	100 - 240 V a.c 50 - 60 Hz	
Voltage fluctuation	±10 % of the power supply voltage	
Power consumption	Total	Approx 4.3 VA (220 V a.c 60 Hz)
	Preset	Approx 6.2 VA (220 V a.c 60 Hz)
Display method	Red FND 4 digits (character height : 8 mm)	
Control output	Contact	SPDT (1c), 250 V a.c 3 A resistive load, cos ϕ = 0.4
	Non-contact	NPN open collector, 30 V d.c max, 100 mA max
ONE SHOT output time	Set by the front TM volume (0.1 s ~ 12.5 sec)	
Input type	Voltage input	High level voltage : 5-30 V d.c Low level voltage : 0-2 V d.c, Input impedance : approx 4.7 k Ω
	Non-voltage type	Impedance when breaks : 1 k Ω max Remaining voltage when breaks : 2 V, Impedance when opens : 100 k Ω min
Min input time	RESET	20 ms min
	INHIBIT	20 ms min (Applicable when using timer)
CP1,CP2 computation speed	30 cps	: contact/non-contact, minimum signal time 16.7 ms
	5 kcps	: non-contact, minimum signal time 0.1 ms (when ON/OFF = 1:1)
Power backup selectable	Power failure compensation/power reset selectable, semi-permanent when selecting power failure compensation(use EEPROM)	
Setting type	Recognize at all times (possible to modify in the middle of applying electric current)	
External power supply	12 V d.c ±10 %, 100 mA max	
Timer action error	Repeating operation error	Less than ± 0.01 % ± 0.05 sec (only with the power start) Less than ± 0.005 % ± 0.003 sec (only with the reset start)
	Setting error	
	Voltage error	
	Temperature error	
Relay life	Mechanical	1 million times min
	Electrical	100 thousand times min (250 V a.c 2 A resistance load)
Insulation resistance	100 M Ω min (500 V d.c mega electric conduction terminal-non recharging metal)	
Dielectric strength	2000 V a.c 60 Hz for 1min (different charging terminal from each other)	
Noise immunity	Square wave noise due to the noise simulator (1 μ s pulse width) ±2 kV (between the operation power terminal)	
Vibration	Durability	Durability / 10 ~ 55 Hz, 0.75 mm, X, Y, Z each direction for 1 hour
	Malfunction	10 ~ 55 Hz, 0.5 mm, X, Y, Z each direction for 10 minutes
Shock	Durability	300 % (30G) X, Y, Z each direction for 3 times
	Malfunction	100 % (10G) X, Y, Z each direction for 3 times
Ambient temperature	-10 ~ 55 °C (with no icing)	
Ambient humidity	35 ~ 85 % R.H	
Storage temperature	-20 ~ 65 °C (with no icing)	
Weight	Total	GF4-T40N : 168 g
	Preset	GF4-P41N : 184 g, GF4-P41S : approx 100 g

Part name and functions

GF4-P41N / GF4-P41S

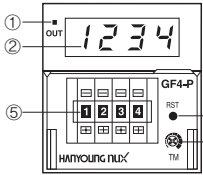

①	Output action LED	Light ON when control output ON
②	Computation/Time displaying unit	Display the computed value of counter action, display the action time in timer action
③	Reset key	Reset the computed value of counter or operation time of counter, Applied when changing the counter and timer action specification
④	TM volume	Set the operation time of control output by the one-short time (setting range : 0.1 ~ 12.5 s)
⑤	Digital switch	Set the computed value of counter or operation time of timer

GF4-T40N

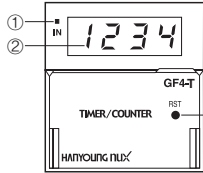

①	Input action LED	When output happens in output line, IN is flickered
②	Computation/Time displaying unit	Display the computed value of counter action, display the action time in timer action
③	Reset key	Reset the computed value of counter or operation time of counter, Applied when changing the counter and timer action specification

Mode selection

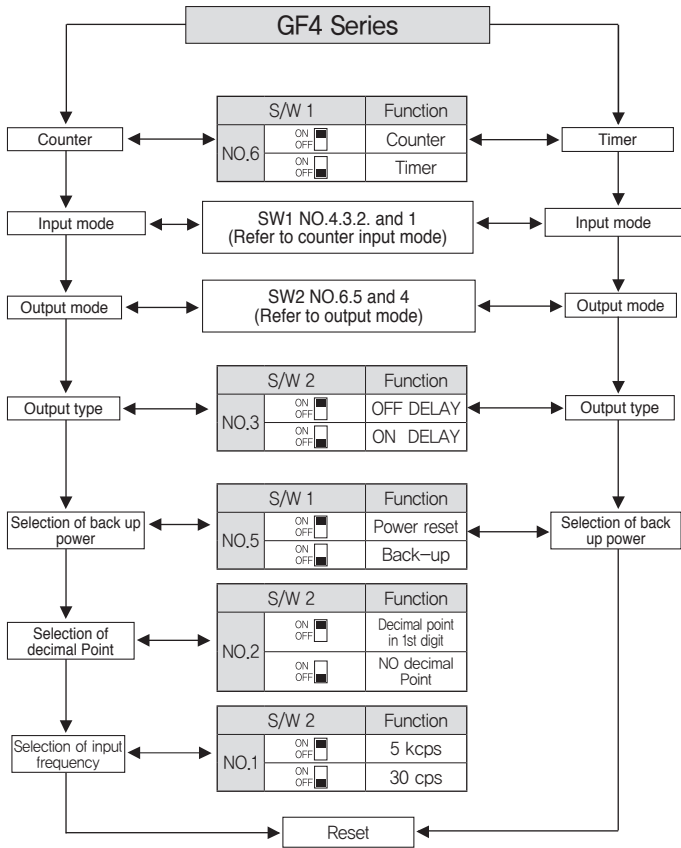

Function

Input logic setting

1. Please Cut the power of GF4 off
2. Please set the switch for controlling Voltage(PNP)/NON- Voltage(NPN) input attached on the side of case to fit with the exterior input
3. If you supply the power of GF4 after setting end, 'Counter/Timeareoperated according to the input situation of Voltage(PNP)NON-Voltage(NPN) set. Caution) when you change the input setting of Voltage(PNP)NON-Voltage(NPN), please chage after power isolation

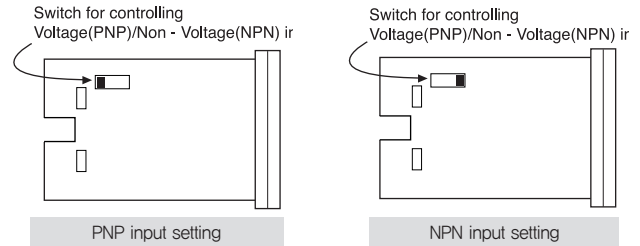

Decimal point selection

S/W 2		Display
NO.2	OFF <input type="checkbox"/>	888.8
	ON <input type="checkbox"/>	8888

One Short time setting



Setting of one short time by TM (0.1 ms ~ 12.5 s variable)

TM

Maximum counting speed

- Rating of maximum counting speed (MCS) is response speed in case of input for 1:1 duty ratio.
- Though input signal is in the MCS, if ON/OFF time is lower than the rating of minimum input signal width, counting is not operated.
- Please use a reliable contact in case of contact input

S/W 2		MCS	Minmum Signal Time
NO.1	OFF <input type="checkbox"/>	5 kcps	0.1 ms min
	ON <input type="checkbox"/>	30 cps	16 ms min

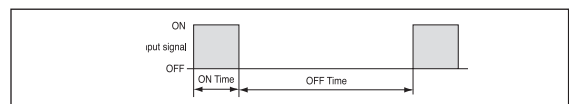

Power supply

Please note that voltage of inside circuit is increasing or decreasing in time between 100 ms after power on and 200 ms after power off.

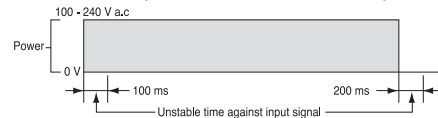

Power for sensor

- 12 V d.c 100 mA max of power for sensor is built-in.
- Proximity awitch - approx 10 mA
- Rotary encoder - approx 30 mA

Function setting

GF4-P41N / GF4-T40N

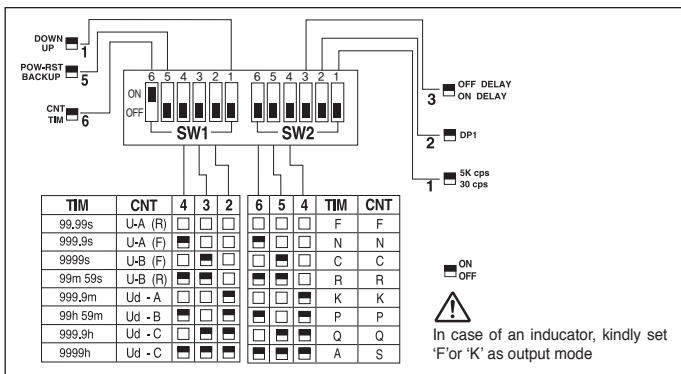

GF4-P41S

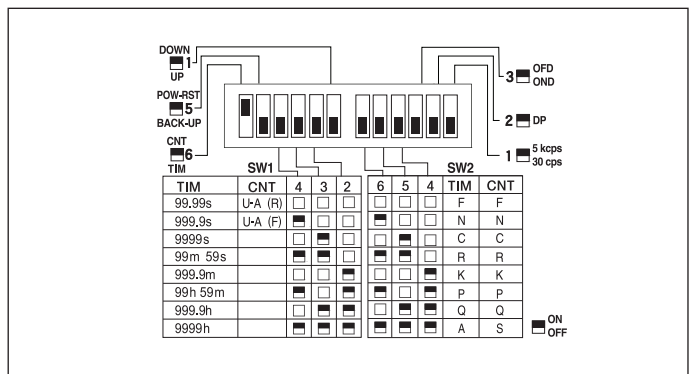

Input Connection

Input connection when the exterior equipment is 'NPN' output

Non-contact input(NPN voltage output)

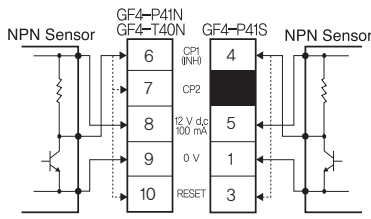

Contact input (NPN)

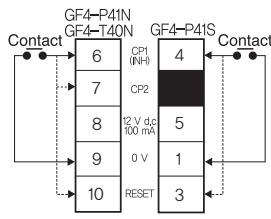

Non-contact input(NPN open collector output)

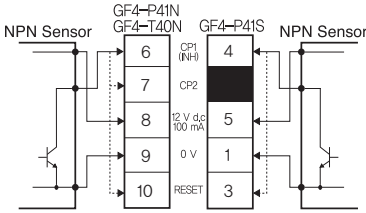

- Please change 'NPN/PNP' S/W attached in the side of 'GF4' into the direction 'NPN' when the exterior equipment is 'NPN'.
- Set counting speed as 30 cps in case of using contact and then use it.

Input connection when the exterior equipment is 'PNP' output

Non-contact input(PNP voltage output)

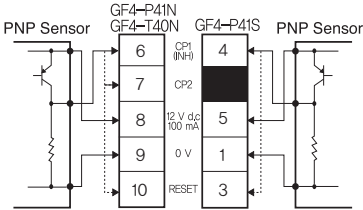

Contact input (PNP)

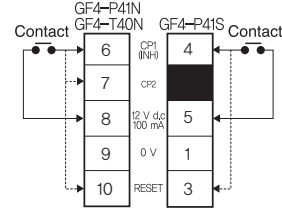

Non-contact input(PNP open collector output)

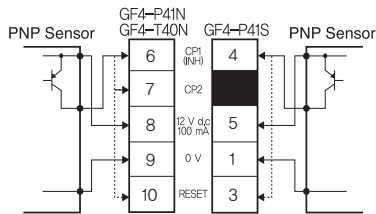

- Please change 'NPN/PNP' S/W attached in the side of 'GF4' into the direction 'NPN' when the exterior equipment is 'NPN'.
- Set counting speed as 30 cps in case of using contact and then use it.

Timer range

SW1	UP mode	SW1	Down mode
ON OFF 4 3 2 1	99.99s	ON OFF 4 3 2 1	99.99s
ON OFF 4 3 2 1	999.9s	ON OFF 4 3 2 1	999.9s
ON OFF 4 3 2 1	9999s	ON OFF 4 3 2 1	9999s
ON OFF 4 3 2 1	99m59s	ON OFF 4 3 2 1	99m59s
ON OFF 4 3 2 1	999.9m	ON OFF 4 3 2 1	999.9m
ON OFF 4 3 2 1	99h59m	ON OFF 4 3 2 1	99h59m
ON OFF 4 3 2 1	999.9h	ON OFF 4 3 2 1	999.9h
ON OFF 4 3 2 1	9999h	ON OFF 4 3 2 1	9999h

*0' display in reset(up count) *Set value' display in reset (Down count)

(Cautions)

- 0 is display when reset signal is inputted in the UP mode.
- Set value is displayed when reset signal is inputted un the DOWN mode.
- Time range of GF4 socket type is same as GF4 terminal type.

Counter input action

GF-P41N / GF4-T40N

- * 'A' requires over minimum signal width and 'B' requires over half of minimum signal width.
- * The following input logic of counter input mode is for the 'PNP' mode.
- * When input logic is set as the 'NPN' mode, please use it is reverse of the 'PNP' mode.

- Ring state of the input signal ()
- Falling state of the input signal ()

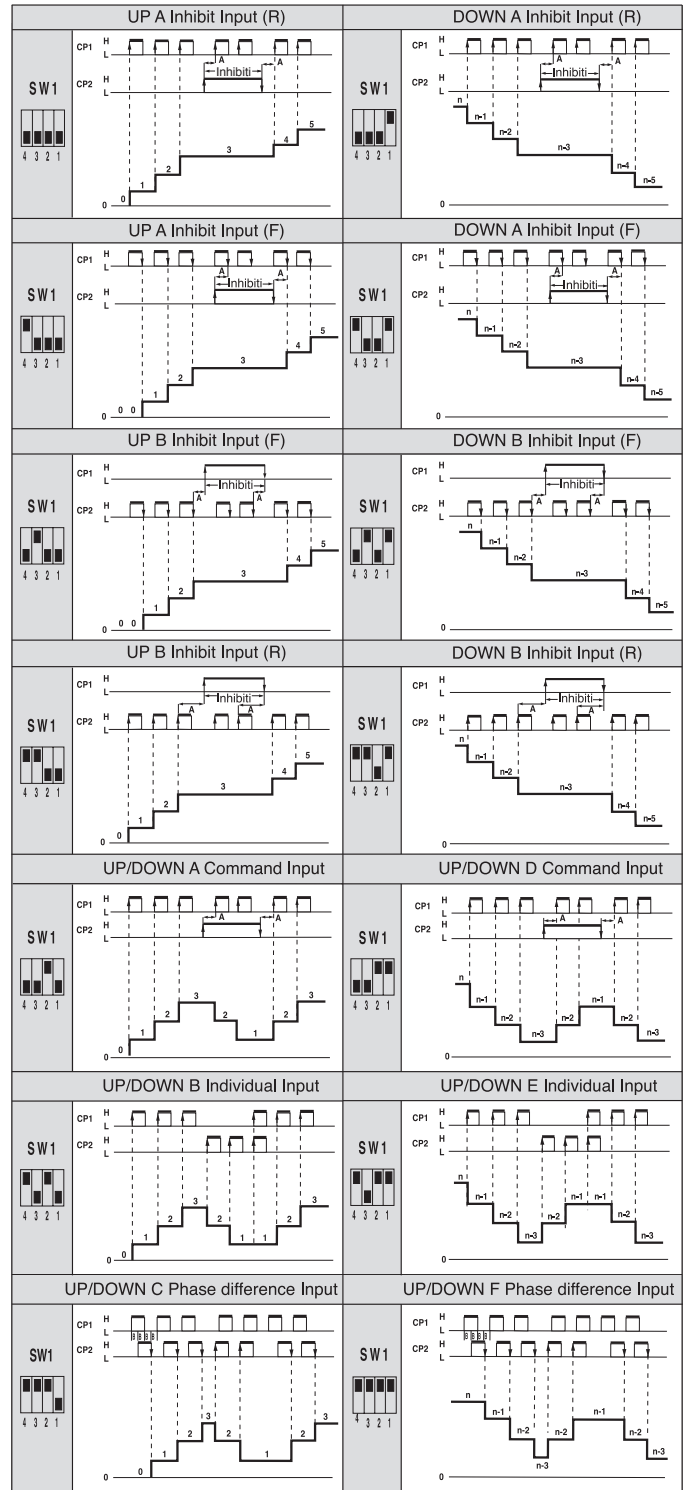

GF-P41S

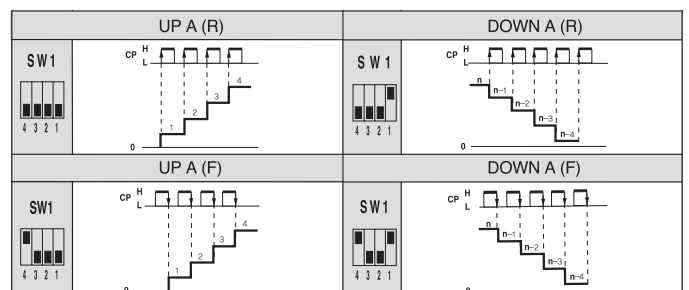

Counter output action

Self maintaining ONE SHOT output (0.1 ~ 12.5 sec setting)

Input mode	Up mode	Down mode	Operation explanation
F SW2 6 5 4 Counter / Timer			<ul style="list-style-type: none"> Disregarding the output occurrence, indicated value will continuously increase or decrease. Until reset signal is applied in, indicated value will continuously increase or decrease and output state will be maintained.
N SW2 6 5 4 Counter / Timer			<ul style="list-style-type: none"> Indicated value will not be displayed once the output is generated. Until Reset signal is applied in, indicated value and output state will be maintained.
C SW2 6 5 4 Counter / Timer			<ul style="list-style-type: none"> Indicated value will be initialized the output is generated. Output state will be maintained for the output set time. Output will be initialized once the output set time is elapsed. Disregarding the set time of output, indicated value will continuously increase or decrease.
R SW2 6 5 4 Counter / Timer			<ul style="list-style-type: none"> Indicated value will not be displayed once the output is generated. Output state will be maintained for the output set time. Indicated value and output will be initialized once the output set time is elapsed.
K SW2 6 5 4 Counter / Timer			<ul style="list-style-type: none"> Disregarding the output occurrence, indicated value will continuously increase or decrease. Output state will be maintained for the output set time. After passing the output set time, output will be initialized without indicated value being changed.
P SW2 6 5 4 Counter / Timer			<ul style="list-style-type: none"> Indicated value will not be displayed once the output is generated and computed value will be initialized. Output state will be maintained for the output set time and computed value will continuously increase, decrease or stop. Output will be initialized after passing the output set time and the increased or decreased computation value will be displayed.
Q SW2 6 5 4 Counter / Timer			<ul style="list-style-type: none"> Disregarding the output occurrence, indicated value will either be increased or decreased continuously. Output state will be maintained for the output set time. Indicated value and output will be initialized after passing the output set time.
S SW2 6 5 4 Counter / Timer			<ul style="list-style-type: none"> When using the UP mode and if the indicated value is higher than the set value then output will be generated and if the indicated value is lower than the set value then output state will be maintained. When using the DOWN mode and if the indicated value is lower than 0 then output will be generated and if indicated value is higher than 0 then output will be initialized. If Reset signal is applied in, indicated value and output will be initialized.
A SW2 6 5 4 Counter / Timer			<ul style="list-style-type: none"> When using the UP mode and if indicated value is higher than the set value then output will be reversed and indicated value will be initialized. When using the DOWN mode and if indicated value is lower than 0 then output will be reversed and indicated value will be initialized. If Reset signal is applied in, indicated value and output will be initialized.

Dimension & Panel Cutout

[Unit : mm]

GF4-P41N / GF4-T40N

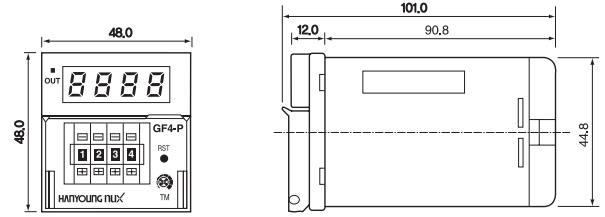

GF4-P41S

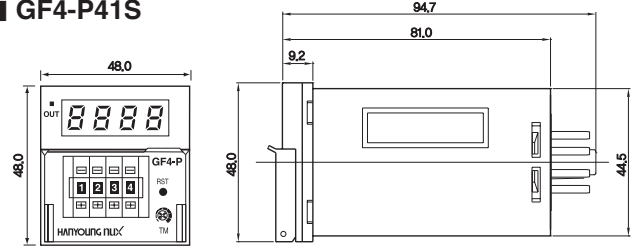

GF4 panel cutout

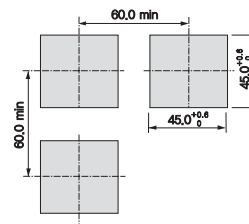

Connection

GF4-P41N

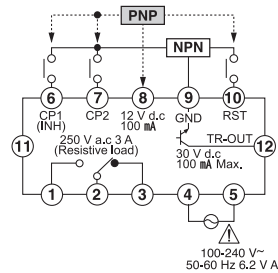

GF4-T40N

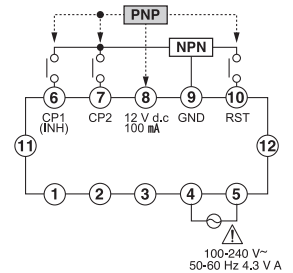

GF4-P41S

