

FE e-Front runners

Variable Torque Load Inverters for Fans and Pumps

FRENIC-ECO Series



FRENIC **Eco**



FUJI HVAC INVERTERS

GREAT PERFORMANCE THROUGH DEDICATED DESIGNS
WELCOME TO NEW GENERATION OF INVERTER
FOR HEATING, VENTILATING & AIR CONDITIONING.



UL US LISTED



MEH442d

Exclusive fan and pump inverter eliminates

Energy saving effects are even further enhanced!

Industry first! Energy-saving operation function of a new system

In previous models, the energy saving operation function corresponded with the load state, and controlled operation to minimize loss of the motor itself. The newly developed FRENIC-Eco Series has shifted the focus from the motor to the inverter, recognizing that the inverter itself is an electrical product, and the new models are equipped with **a new control system that minimizes the power consumed by the inverter itself (inverter loss) as well as the power loss in the motor itself.**

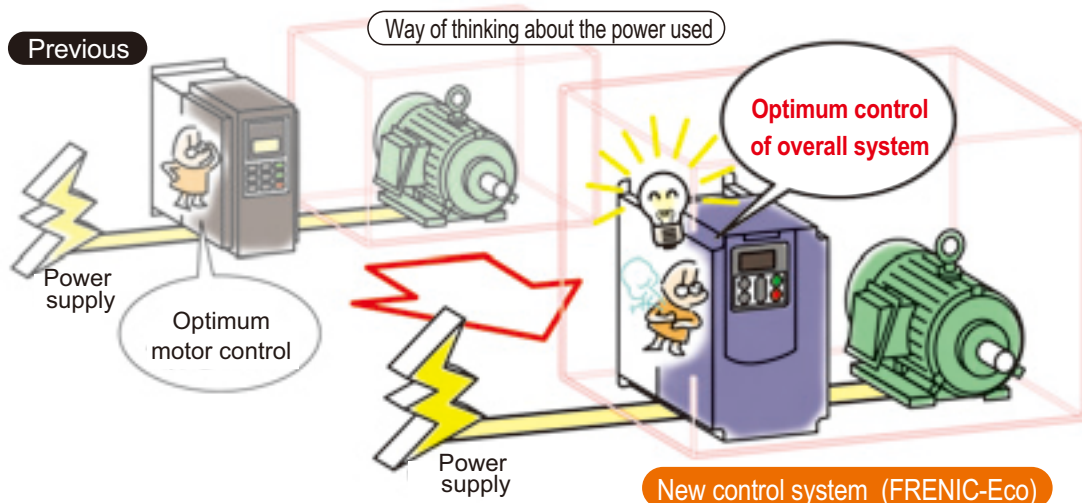

Using this new system, energy savings is several percent improved over that of the previous models.

Kyoto Agreement, which was studied at the Conference on Prevention of Global Warming (COP3), was ratified by Russia in October 2004, and thereby put into effect on February 16, 2005. In the future, the related regulations are calling for a reduction in energy consumption of 1% or more each succeeding year, and therefore, we are aiming to build energy saving features into equipment as a whole. **FRENIC-Eco is the inverter equipped with the industry's highest level of efficiency (low power loss).**

Power Monitor

Power-related data can be checked at the inverter unit's keypad.

Items
Power (kW)
Cumulative power (kWh)
Cumulative power rates (yen/kWh)

* Cumulative values can be reset. Cumulative power rates are shown with the power rate set at so much per kWh (display coefficient). Rates in other currency can also be displayed.

Energy saving effect compared with Fuji's previous models

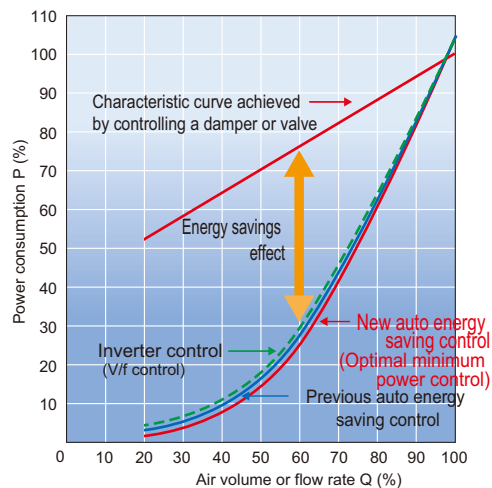

(The effect varies dependent on the motor's characteristics.)

Long life design that meets your expectation!

Built with longer lasting replaceable components to give a longer service life!

The design life of replaceable components in each inverter model has been extended to **10 years**. In addition, the capacity of the main circuit capacitors is measured and temperature compensation carried out to match the cumulative operating time of the electrolytic capacitors on the printed circuit board.

Life-limited component name	Designed life
Main circuit capacitors	10 years
Electrolytic capacitors on printed circuit board	10 years
Cooling fan (Note)	10 years

Note: 7 years for 37kW or larger models
 [Conditions] Ambient temperature: 40°C, Load factor: 80% of inverter's rated current
 *The life may be shorter depending on surrounding conditions.

waste, saves energy and cuts costs.



Maintenance is simplified for both the inverter and equipment !

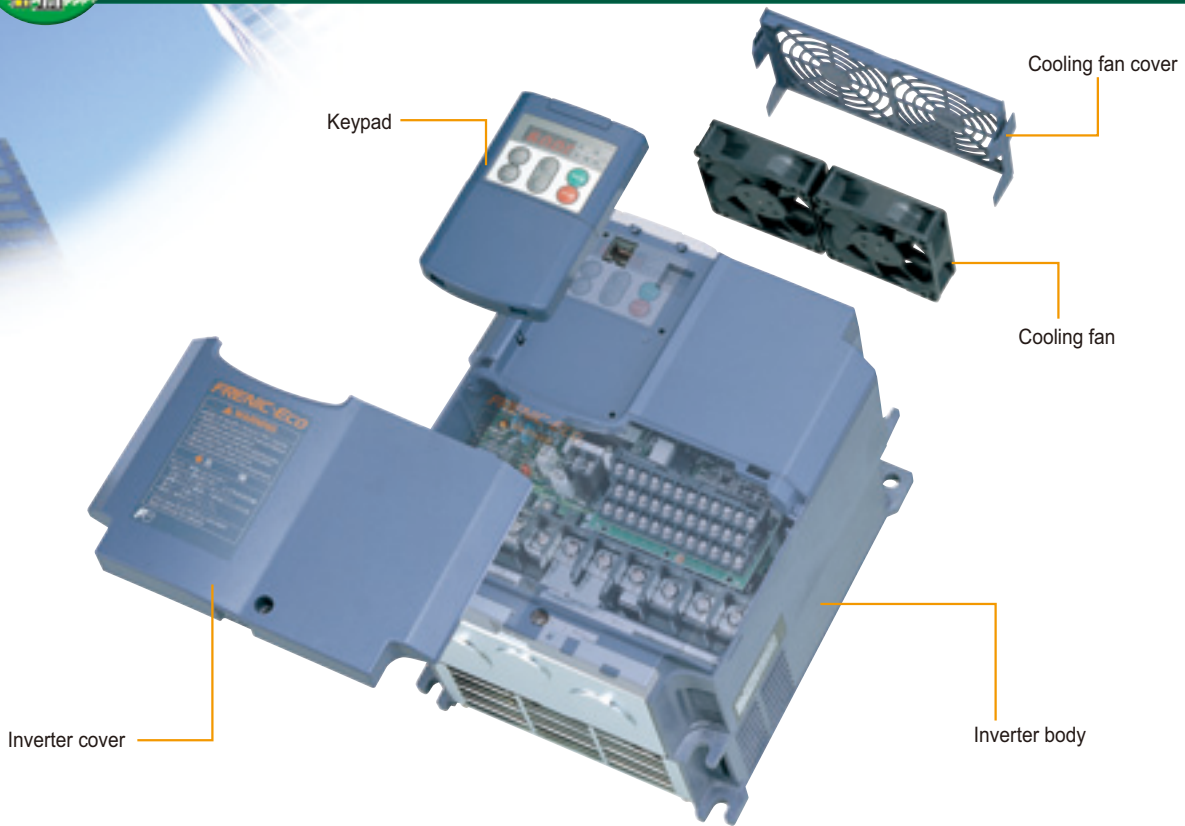

The service life information for replaceable inverter components is displayed.

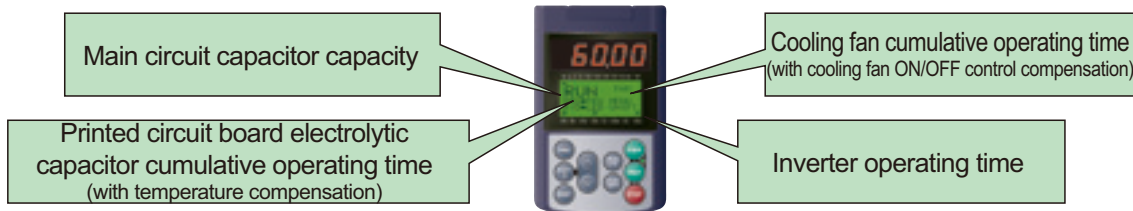

Simple replacement of replaceable components

Cooling fan replacement procedure

●15kW model



Cooling cover can be removed with one touch.



Disconnect the power connector and change the cooling fan cartridge.

●45kW model



The inverter's mounting screws and power connector can be removed from the front.



The cooling fan cartridge can be replaced by sliding the holder out to the front

Industry first

Information is displayed with equipment maintenance in mind.

In addition to maintenance information for the inverter unit, information related to equipment maintenance is also displayed.

Item	Purpose
Motor cumulative operating time (hours)	<p>The cumulative operating time of the equipment the inverter is used with is calculated.</p> <p>Example of Use If the inverter is used for fan control, this time can be used as a criterion for replacing the belts used on pulleys.</p>
Number of starts (times)	<p>The number of times the inverter is run and stopped can be counted.</p> <p>Example of Use The number of times the equipment is started and stopped is recorded, so this can be used as a criterion for replacing parts in equipment where starting and stopping is a burden on the machine.</p>

Specifications

Protective Functions

External Dimensions

Wiring Diagram

Terminal Functions

Keypad Operations

Function Settings

Peripheral Equipment Connection Diagrams

Options

Guideline for Suppressing Harmonics



Equipped with the optimum functions for HVAC (Air conditioning systems) !

Operation is continued even after the momentary power failure thanks to the auto-restart function.

Even if a momentary power failure occurs, load inertia of a fan or blower, etc. is used to maintain the motor's operation while the motor's operating speed gradually drops, and enables the motor to restart operation without stopping. (The motor may stop on occasion due to the load's inertial moment.)

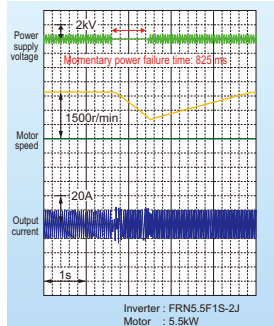

A pick-up function provides smooth starts.

If you desire to run a fan which the inverter is not currently running and which is turning free, this function will pick up on its motion regardless of the direction it is turning in and start it operating. Momentary switching is performed in the inverter from the commercial power supply and provides a convenient function when starting motors, etc.

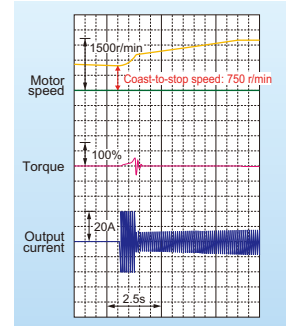

Tripless operation through regenerated current avoidance control

Deceleration time is controlled to match the internal energy level generated in the inverter, and so deceleration and stopping is accomplished without tripping due to overload.

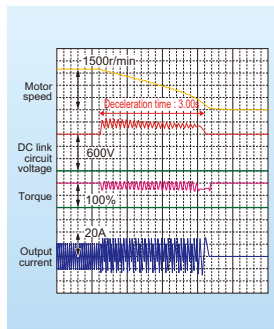

Even greater energy savings through the low water volume stop function

When there is pump operation accompanying "pressure drop" that occurs due to pressure loss or leakage, etc. in the piping, etc., or at times when the pump runs repeatedly to obtain a small volume of water, this function controls the pump's operation, preventing it from being driven with the water volume below a predetermined level, and thus reducing wasteful pump operation and saving even more energy.

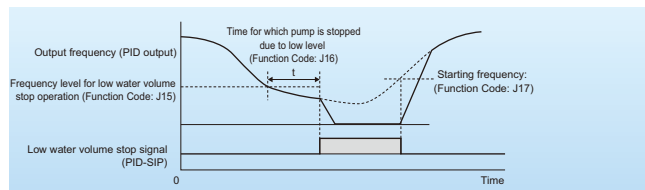

The equipment's operating condition is determined by the low torque detection function.

The inverter determines the load state of the connected motor and if it drops below a predetermined level, it judges that a "Low Torque" state exists and outputs a signal to that effect. In this way, any trouble that occurs in the equipment (such as a belt on a pulley breaking) can be grasped by the inverter.

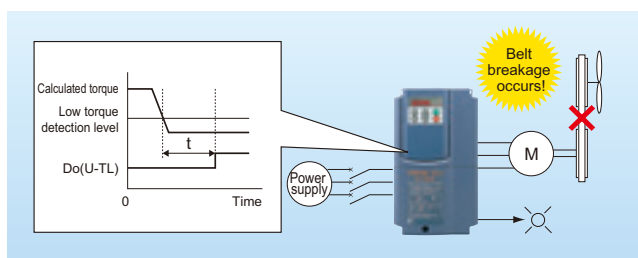

Also avoids operation signal trouble through the command loss detection function.

If the frequency signals (0 to 10V, 4 to 20mA, multi-step speed operation signals, communications, etc.) that are connected to the inverter are blocked, signals are output as a "command loss," indicating that a frequency command was lost. In addition, output frequency when the command loss occurred can be set in advance, so even if a frequency signal line to equipment is broken due to machine vibration, etc., machine operation can be continued uninterruptedly.

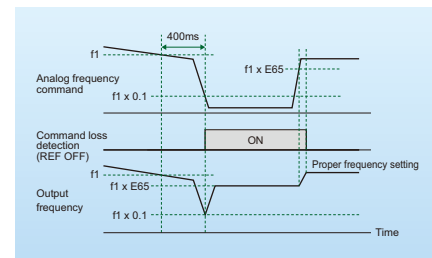

Simple circuit configuration using the commercial line switching sequence

Inverters are equipped with the commercial line start function that enables switching between the commercial line and the inverter by an external sequence. In addition, inverters are equipped with two types of built-in sequence for operation with commercial line; i.e., Fuji's standard sequence and the automatic switching sequence to the commercial line activated when the inverter alarm occurs.

Note: The latter sequence differs from the one for forcible switching to the commercial line during inverter breakdown.

Inverters are equipped with full PID control functions.

Low water level stop function, deviation alarm and absolute value alarm outputs have been added to the PID regulator which performs such tasks as temperature, pressure and flow rate control. In addition, an anti-reset windup function that prevents PID control overshoot as well as a PID output limiter and integral hold/reset signal provide easy-to-adjust PID control functions.

Continuous equipment operation through overload avoidance control

If the load on a fan or pulley increases due some foreign object getting wrapped around the shaft, etc., and the inverter's internal temperature rises suddenly or the ambient temperature rises to an abnormal level, etc., causing an inverter overload state, the motor's speed is lowered, reducing the load and enabling operation to continue.

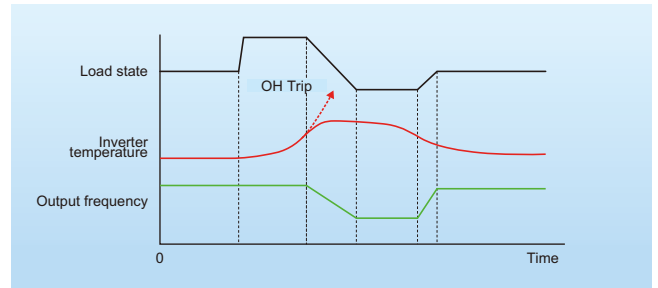

Simple Sequences through Universal DI/DO

Signals can be transmitted to a higher level controller or PC by connecting digital signals to an inverter from different types of sensors, such as a float switch used to judge the level in a water storage tank, which serve as peripheral devices to the inverter. In the case of small-scale equipment, even if a programmable logic controller (PLC) is not used, information can be sent to a higher-level system easily.

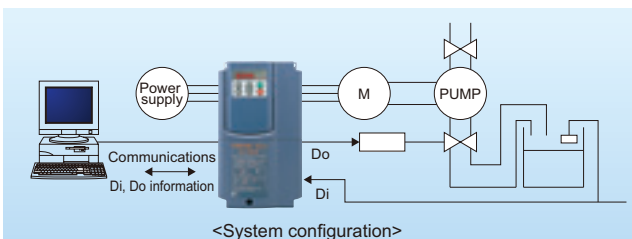

Elimination of display devices by use of the analog input monitor

Using the display coefficient of signals from devices such as flow rate or temperature sensors in air conditioning equipment, these signals can be converted into physical values such as temperature and pressure and displayed synthetically on the inverter's keypad without making the use of exclusive flow meters or air flow meters.

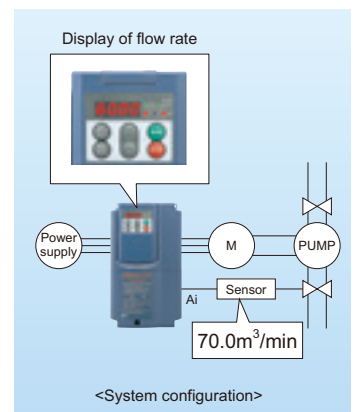

Improved capability for handling regenerated energy

When the inverter slows down and stops the motor, if the braking energy regenerated by the motor exceeds the braking capacity of the inverter's main circuit capacitor, the inverter will trip. At such a time, if even a little excess energy trips the inverter, using this function you may be able to absorb the excess braking energy without connecting to a braking resistor.

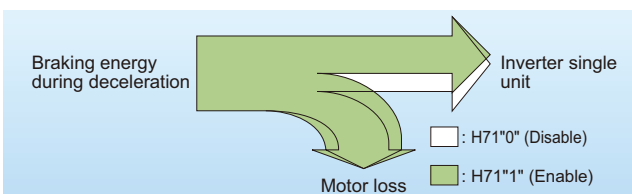

Other convenient functions

●Motor condensation prevention function

Prevents condensation of the motor from occurring in cases where the surrounding temperature changes suddenly while the motor is stopped.

●Motor speed display with percent

The inverter's keypad displays the operating frequency (Hz) or the motor's rotational speed (r/min), but it can also display the maximum speed as 100%, so it is easy to get a grasp of the equipment's operating state.

Dynamic Rotation of Pump Motors

●With a fixed inverter-driven motor

This configuration consists of a motor driven by the inverter (M0) and motors driven by commercial power (M1 to M4). The inverter-driven motor is fixed at M0 and is controlled for variable speed. When the inverter-driven motor M0 alone cannot sustain the desired discharge flowrate, the inverter mounts one or more motors driven by commercial power as necessary.

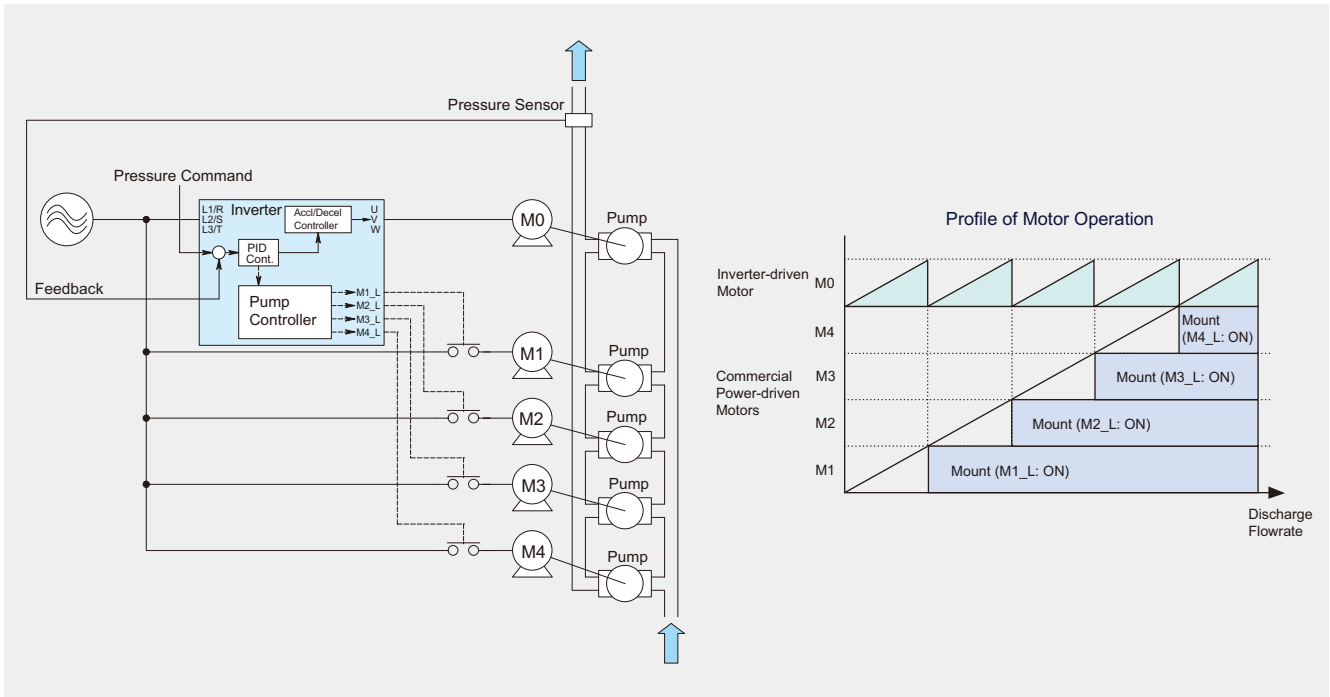

●With a floating inverter-driven motor

In this configuration, all the motors can be driven by the inverter or commercial power. At the start of operation, each motor is driven by the inverter and is controlled for varying speed. When the first motor alone cannot sustain the desired discharge flowrate, it is switched to commercial-power operation, and the inverter drives the second motor.

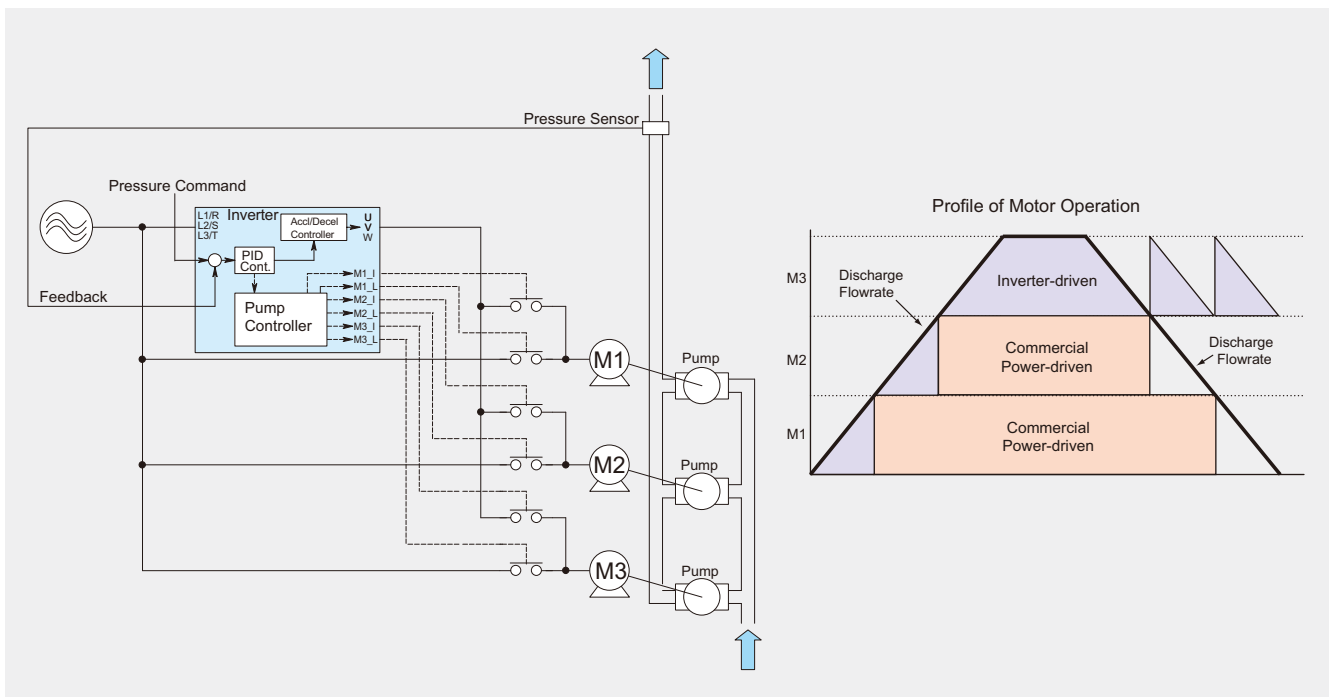



Consideration of the surrounding environment and panel design !

Integration with a DC reactor enables Fuji Inverters to meet "Public Building and Construction Standards" Supervised by Ministry of Land, Infrastructure and Transport!

Fuji's standard series, including our DC reactors and zero phase reactors, complies with the inverter installation standards in the "Public Building and Construction Standards (Electrical Equipment Construction Manual)" issued in 2004 by Ministry of Land, Infrastructure and transports's Secretarial Office in charge of Government Buildings Department.

In addition, our integrated inverter/DC reactor units have built-in DC reactors and zero phase reactors, so they comply in the area of wiring. (See Note.)

Remark : In the Public Building Association's "Electric Construction Equipment Common Specifications (published in 1999) it stated that it is necessary to install a capacitance filter when installing inverters, but in the specifications published in 2001, it became unnecessary. Also, Fuji's inverter series, including the FRENIC-Eco series have built-in capacitance filters.

Note : 22kW or lower capacity inverters comply with the above specifications as is. Those models with a capacity of 30kW or greater can be made to comply with the specifications by adding an optional zero-phase reactor.



Reduction of noise with an Integrated EMC filter (It includes a CE mark which means that it is compatible with EMC Directives and low voltage Directive.)

In models which include an integrated EMC filter (15 kW or lower capacity), through the installation along the lines of the installation procedures for integrated devices, these inverters comply with Europe's EMC Directives.

Side-by-side installation saves space!

If multiple inverter units are to be used in a panel and the panel is designed accordingly, it is possible to mount these inverters side-by-side horizontally, so the panel can be designed to take up less space. (5.5kW or lower capacity inverters)

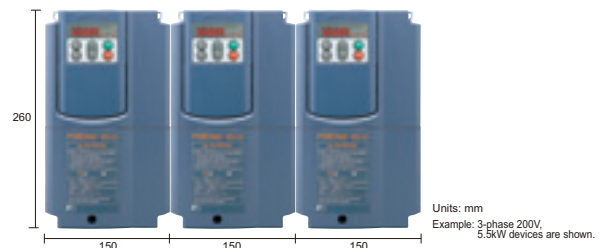

Built-in in rush current suppressing resistors help reduce peripheral equipment capacities!

When the FRENIC-Eco series (Fuji's FRENIC-Mini Series and 11 Series) is used, the in rush current suppressing resistors built into the inverter as standard equipment suppress in rush current when motors are started, so compared to operation of motors with direct input, peripheral equipment with reduced capacity can be selected.

Cooling outside the panel is made possible by an external cooling attachment!

Use of the external cooling attachment (optional on 30kW or smaller inverters and standard on 37kW or larger inverters) to cool the inverter outside the panel makes it possible to install a simple cooling system outside the panel.



Operator-friendly features !

Inverters can be set up simply using Quick Setup.

The standard keypad can be used to select Quick Setup from the Menu mode. In Quick Setup, you can display 18 different function codes and set up the inverter simply.



A keypad that enables remote operation is standard equipment.

The standard keypad has a decorative cover on the bottom that can be slid sideways and removed. A LAN cable can be used to connect the panel, making it possible to use it as a remote operation keypad.

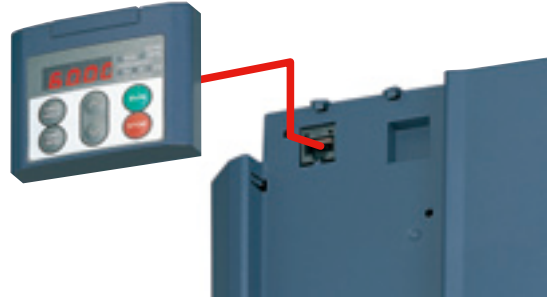

A multi-function keypad is also available as an option.

■ TP-G1 ■ TP-G1-J1 ■ TP-G1-C1

- Includes an easier to see LCD with backlight.
- It has a large 7-segment, 5-digit LED display.
- It is possible to add and delete quick setup items.
- A remote/local switching key has been newly added.
- Copying of up to 3 sets of data is possible.



Option type	Display languages							
	English	German	French	Spanish	Italian	Chinese	Korean character	Japanese
TP-G1	<input type="checkbox"/>	<input type="checkbox"/>	<input type="checkbox"/>	<input type="checkbox"/>	<input type="checkbox"/>	-	-	<input type="checkbox"/>
TP-G1-J1	<input type="checkbox"/>	<input type="checkbox"/>	<input type="checkbox"/>	<input type="checkbox"/>	<input type="checkbox"/>	-	-	<input type="checkbox"/>
TP-G1-C1	<input type="checkbox"/>	-	-	-	-	<input type="checkbox"/>	<input type="checkbox"/>	<input type="checkbox"/>

Personal computer loader software



Store, manage and verify settings data.



Monitoring



Real-time tracing



Maintenance Information



Operation

*These pieces of software can be downloaded from the following Fuji Electric web site:
<https://web1.fujielectric.co.jp/Kiki-Info-EN/User/guestlogin.asp>



Network compatibility !

- RS-485 communications (connector) is standard.
- It is compatible with the following networks by inserting the relevant option card.

- DeviceNet
- LonWorks Network
- PROFIBUS DP
- CC-Link
- RS-485 communications (terminal block type)



Global compatibility !

European Union
EC Regulation (CE mark)



North America/Canada
UL Standards (cUL certified)





Model Variations

Model List

Applicable motor rating (kW)	Standard type		Semi-standard type					
			DC REACTOR built-in typ		EMC filter built-in type		Waterproof type (IP54)	
	Three-phase 200V series	Three-phase 400V series	Three-phase 200V series	Three-phase 400V series	Three-phase 200V series	Three-phase 400V series	Three-phase 200V series	Three-phase 400V series
0.75	FRN0.75F1S-2A	FRN0.75F1S-4A	FRN0.75F1H-2A	FRN0.75F1H-4A	FRN0.75F1E-2A	FRN0.75F1E-4A	FRN0.75F1L-2A	FRN0.75F1L-4A
1.5	FRN1.5F1S-2A	FRN1.5F1S-4A	FRN1.5F1H-2A	FRN1.5F1H-4A	FRN1.5F1E-2A	FRN1.5F1E-4A	FRN1.5F1L-2A	FRN1.5F1L-4A
2.2	FRN2.2F1S-2A	FRN2.2F1S-4A	FRN2.2F1H-2A	FRN2.2F1H-4A	FRN2.2F1E-2A	FRN2.2F1E-4A	FRN2.2F1L-2A	FRN2.2F1L-4A
3.7	FRN3.7F1S-2A	FRN3.7F1S-4A	FRN3.7F1H-2A	FRN3.7F1H-4A	FRN3.7F1E-2A	FRN3.7F1E-4A	FRN3.7F1L-2A	FRN3.7F1L-4A
5.5	FRN5.5F1S-2A	FRN5.5F1S-4A	FRN5.5F1H-2A	FRN5.5F1H-4A	FRN5.5F1E-2A	FRN5.5F1E-4A	FRN5.5F1L-2A	FRN5.5F1L-4A
7.5	FRN7.5F1S-2A	FRN7.5F1S-4A	FRN7.5F1H-2A	FRN7.5F1H-4A	FRN7.5F1E-2A	FRN7.5F1E-4A	FRN7.5F1L-2A	FRN7.5F1L-4A
11	FRN11F1S-2A	FRN11F1S-4A	FRN11F1H-2A	FRN11F1H-4A	FRN11F1E-2A	FRN11F1E-4A	FRN11F1L-2A	FRN11F1L-4A
15	FRN15F1S-2A	FRN15F1S-4A	FRN15F1H-2A	FRN15F1H-4A	FRN15F1E-2A	FRN15F1E-4A	FRN15F1L-2A	FRN15F1L-4A
18.5	FRN18.5F1S-2A	FRN18.5F1S-4A	FRN18.5F1H-2A	FRN18.5F1H-4A			FRN18.5F1D-2A	FRN18.5F1L-4A
22	FRN22F1S-2A	FRN22F1S-4A	FRN22F1H-2A	FRN22F1H-4A			FRN22F1D-2A	FRN22F1L-4A
30	FRN30F1S-2A	FRN30F1S-4A	FRN30F1H-2A	FRN30F1H-4A			FRN30F1D-2A	FRN30F1L-4A
37	FRN37F1S-2A	FRN37F1S-4A	FRN37F1H-2A	FRN37F1H-4A			FRN37F1D-2A	FRN37F1L-4A
45	FRN45F1S-2A	FRN45F1S-4A	FRN45F1H-2A	FRN45F1H-4A			FRN45F1D-2A	FRN45F1L-4A
55	FRN55F1S-2A	FRN55F1S-4A	FRN55F1H-2A	FRN55F1H-4A				FRN55F1L-4A
75	FRN75F1S-2A	FRN75F1S-4A	FRN75F1H-2A	FRN75F1H-4A				FRN75F1L-4A
90	FRN90F1S-2A	FRN90F1S-4A						FRN90F1L-4A
110	FRN110F1S-2A	FRN110F1S-4A						
132		FRN132F1S-4A						
160		FRN160F1S-4A						
200		FRN200F1S-4A						
220		FRN220F1S-4A						
280		FRN280F1S-4A						
315		FRN315F1S-4A						
355		FRN355F1S-4A						
400		FRN400F1S-4A						
450		FRN450F1S-4A						
500		FRN500F1S-4A						
560		FRN560F1S-4A						

*Semi-standard specification products are manufactured when orders are received.

How to read the model number

FRN 5.5 F 1 S - 2 A 5 1 1

Code	Series name
FRN	FRENIC series

Code	Applicable motor rating [kW]
0.75	0.75kW
1.5	1.5kW
2.2	2.2kW
3.7	3.7kW
5.5	5.5kW
7.5	7.5kW
11	11kW
15	15kW
?	?
450	450kW
500	500kW
560	560kW

Code	Application range
F	Fans and pumps (For variable torque load)

Code	Developed inverter series
1	1

Code	Control terminal block
1	Screw terminal (standard)
2	Rod terminal

Code	Built-in option
1	None
2	RS-485 communication card

Code	Keypad
1	Keypad (standard)
5	Multi-function keypad
9	No keypad

Code	Version/Manual
A	Asia/English

Code	Input power supply
2	3-phase 200V
4	3-phase 400V

Code	Structure
S	Standard type(IP20/IP00)
H	DC REACTOR built-in type(IP20)
E	EMC filter built-in type(IP00)
L/D	Waterproof type(IP54)

Note: When the lower three digits of the model number indicate a keypad (standard), no built-in option, and screw terminals (standard), the inverter is a standard type in the above model list. There may be some nonstandard models that we cannot manufacture.

Caution Use the contents of this catalog only for selecting product types and models. When using a product, read the Instruction Manual beforehand to use the product correctly.



Energy Savings with an Inverter

How does using an inverter save me energy?

- If you run a fan or pump and you have damper (valve) control or control it with an inverter, the relation between the air flow (flow rate) and the required power, as well as the relation between the power supply frequency f_s (Hz) and operating frequency with the inverter f_{INV} (Hz) are as shown in the table at right.
- If the air flow rate is low, the energy saving effect is particularly great.

Item	Relation between f_s (Hz) and f_{INV} (Hz) (Note 1)	Examples with actual numbers (Note 2)	
		$f_{INV}=45[\text{Hz}]$ (10%DOWN)	$f_{INV}=30[\text{Hz}]$ (40%DOWN)
Air flow or flow rate Q [m^3/min]	$Q \propto \left(\frac{f_{INV}}{f_s}\right)$	$Q = \frac{45}{50} \cdot Q = 0.9 \cdot Q$	$Q = \frac{30}{50} \cdot Q = 0.6 \cdot Q$
Head H (m) or pressure H [Pa]	$H \propto \left(\frac{f_{INV}}{f_s}\right)^2$	$H = \left(\frac{45}{50}\right)^2 \cdot H = 0.81 \cdot H$	$H = \left(\frac{30}{50}\right)^2 \cdot H = 0.36 \cdot H$
Shaft power or power consumption P [W]	$P \propto \left(\frac{f_{INV}}{f_s}\right)^3$	$P = \left(\frac{45}{50}\right)^3 \cdot P = 0.729 \cdot P$	$P = \left(\frac{30}{50}\right)^3 \cdot P = 0.216 \cdot P$

Note 1: Power supply frequency f_s (Hz); operating frequency with the inverter f_{INV} (Hz) Note 2: When $f_s = 50$ (Hz)

Formula (theoretical) for calculating the energy savings effect achieved by an inverter

● Fan equipment

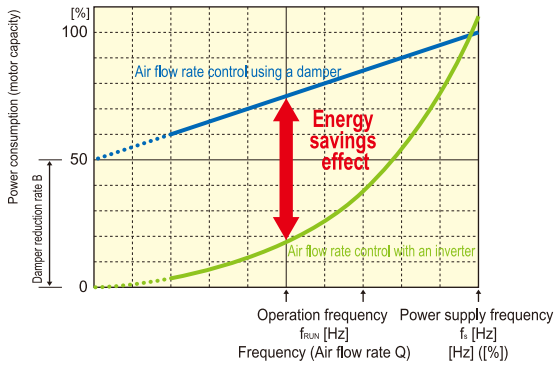

Energy savings effect in monetary terms: M_s (yen/year)

$$= \text{Power charges [yen/year] at the time the damper was used} - \text{Power charges MINV [yen/year] when an inverter is used}$$

Power charges when a damper is used: M_o [yen/year]

$$= (P \times (1 - B) \times Q + P \times B) \times \frac{1}{\eta_M} \times D \times H \times M$$

Power charges when an inverter is used: MINV [yen/year]

$$= \left(P \times \left(\frac{f_{RUN}}{f_s} \right)^3 \right) \times \frac{1}{\eta_M} \times \frac{1}{\eta_{INV}} \times D \times H \times M$$

- P: Motor capacity (kW)
- B: Damper reduction rate (%)
- Q: Air flow (%)
- f_{RUN} : Inverter operating frequency (Hz)
- f_s : Power supply frequency (Hz)
- D: Annual operating days (day/year)
- H: Operating hours per day (h/day)
- M: Power charge unit price (kWh/yen)
- η_M : Motor efficiency (%)
- η_{INV} : Inverter efficiency (%)

(Note 1) The air flow rate Q (%) shows the air flow when the damper is closed (%). The operating frequency f_{RUN} (Hz) when using an inverter is being proportional to the air flow Q (%), so decide on a f_{RUN} (Hz) value so that the relationship Q (%) = f_{RUN} (Hz) / f_s (Hz) is established.

For example, if air flow Q : 60 (%) = Power supply frequency f_s : 50 (Hz)
 Q (%) = f_{RUN} (Hz) / f_s (Hz)
 60 (%) = f_{RUN} (Hz) / 50 (Hz) $\rightarrow f_{RUN}$ (Hz) = 50 (Hz) \times 0.6 = 30 (Hz)

(Note 2) The air flow rate Q (%) does not show the damper's opening angle, but rather the air flow (%) at the point when the opening angle is adjusted from the damper's fully open state. Depending on the type of damper, there may not be a proportional relation between the opening angle and the air flow, so exercise caution.

● Pump equipment

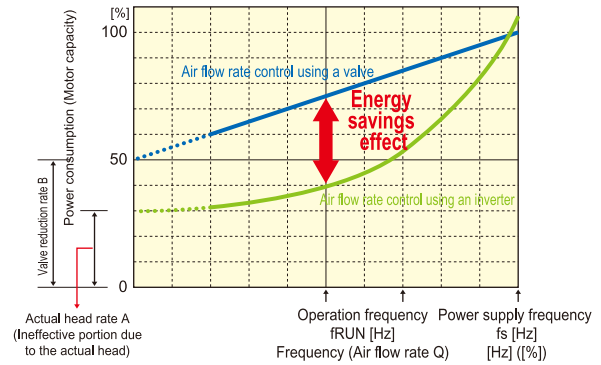

Monetary amount of energy savings effect: M_s [yen/year]

$$= \text{Power charge } M_v \text{ [yen/year] when a valve is used} - \text{Power charge MINV [yen/year] when an inverter is used}$$

Power charge when a valve is used: M_v [yen/year]

$$= (P \times (1 - B) \times Q + P \times B) \times \frac{1}{\eta_M} \times D \times H \times M$$

Power charge when an inverter is used: MINV [yen/year]

$$= \left((P - P \times A) \times \left(\frac{f_{RUN}}{f_s} \right)^3 + P \times A \right) \times \frac{1}{\eta_M} \times \frac{1}{\eta_{INV}} \times D \times H \times M$$

- P: Motor capacity (kW)
- A: Actual head rate (%)
- B: Valve reduction rate (%)
- Q: Flow rate (%)
- f_{RUN} : Inverter operating frequency (Hz)
- f_s : Power supply frequency (Hz)
- D: Annual operating days (day/year)
- H: Operating hours per day (h/day)
- M: Power charge unit price (kWh/yen)
- η_M : Motor efficiency (%)
- η_{INV} : Inverter efficiency (%)

(Note 1) The actual head rate A (%) is determined by the pump's load characteristics and is a rate that the power consumption (motor capacity) is multiplied by. See the following calculation formula.

$$\text{Actual head rate } A \text{ (\%)} = \frac{\text{Loss head (m)}}{\text{Actual head (m)}}$$

(Note 2) The flow rate Q (%) value shows a volume (%) when the flow rate is restricted by the closing of the valve. The operating frequency when an inverter is used f_{RUN} (Hz) is proportional to the flow rate Q (%), so decide on a f_{RUN} (Hz) so that the relationship Q (%) = f_{RUN} (Hz) / f_s (Hz) can be established. For example, if the flow rate Q : 50 (%) and the power supply frequency f_s is 50Hz, Q (%) = f_{RUN} (Hz) / f_s (Hz) 60 (%) = f_{RUN} (Hz) / 50 (Hz) $\rightarrow f_{RUN}$ (Hz) = 50 (Hz) \times 0.6 = 30 (Hz)

(Note 3) The flow rate Q (%) does not show the valve's opening angle, but rather the flow rate (%) at the point when the opening angle is adjusted from the valve's fully open state. Depending on the type of valve, there may not be a proportional relation between the opening angle and the flow rate, so exercise caution.

Energy Savings effect of replacing damper (valve) control with inverter control

Example: The energy savings effect on an office's air conditioning equipment if the operating pattern is as follows: Air flow: 85% for 2,000 hrs, and 60% for 2,000 hrs. Total 4,000 hrs/year. Motor output is 15kW \times 1 unit.

● Under damper (valve) control, the required power is as follows:

$$(15\text{kW} \times 91\% \times 2,000 \text{ hrs.}) + (15\text{kW} \times 76\% \times 2,000 \text{ hrs.}) = 50,100\text{kWh}$$

Air flow rate 85% Air flow rate 60%

● If an inverter is used and the motor's rotational speed is controlled, the required power is as follows:

$$(15\text{kW} \times 61\% \times 2,000 \text{ hrs.}) + (15\text{kW} \times 22\% \times 2,000 \text{ hrs.}) = 24,900\text{kWh}$$

Air flow rate 85% Air flow rate 60%

● The power saving effect when the power charges are 16.8yen/kWh is

$$25,200\text{kWh} \times 16.8\text{yen} = 420,000\text{yen/year}$$

● The amount of time it takes to amortize the equipment cost if the inverter's cost is 450,000 yen is

$$450,000 \text{ yen} / 420,000 \text{ yen} = 1.1 \text{ years}$$

● Also, if we let the CO₂ emissions coefficient be 0.555 kg/kWh (environmental statistics from the Environmental Department of

the Environmental Agency), the annual CO₂ reduction amounts to

$$25,200\text{kWh} \times 0.555 \text{ kg/kWh} = 13,986\text{kg/year}$$

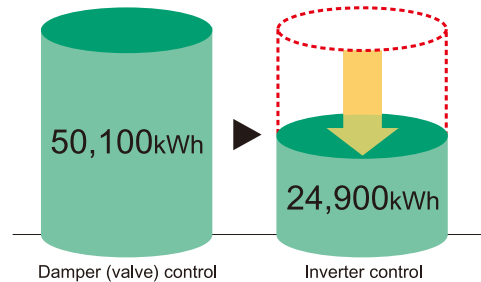

Energy savings effect

$$50,100\text{kWh} - 24,900\text{kWh} = 25,200\text{kWh/year}$$

Examples of measurements with actual equipment

■ Exhaust fan (generating variable torque load)

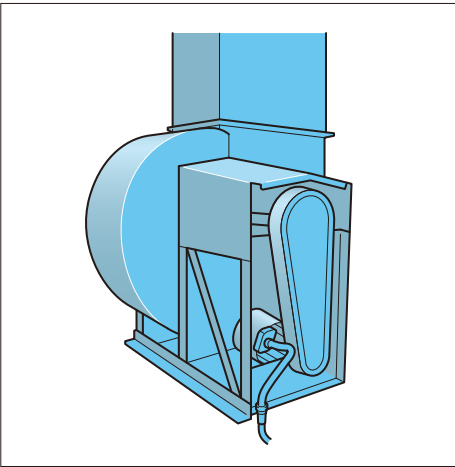

- Motor capacity and inverter capacity
 - Motor capacity : 22 (kW)
 - Inverter model : FRN22F1S-2 (FRENIC-Eco)
 - DC REACTOR : DCR2-22A
- Power reduction rate and energy saving effect amount

Item	Operation using commercial power	Inverter-controlled operation		
		45	40	35
Operation frequency (Hz)	50	45	40	35
Average power use (kW)	17.2	13.1	9.10	6.23
Power reduction rate (%)	-	▲30.7	▲47.1	▲63.8
Annual power charge (yen)	1,574,006	1,198,807	832,759	570,120
Annual amount (yen) of energy saving effect	-	375,199	741,247	1,003,886
Annual CO ₂ reduction volume (kg/year)	-	16,930	33,447	45,298

- Operating conditions
 - Annual operating days : 310 (days/year)
 - Working hours per day : 24 (hrs/day)
 - Power charge unit price : 12.3 (yen/kWh)

■ Cooling tower (generating variable torque load)

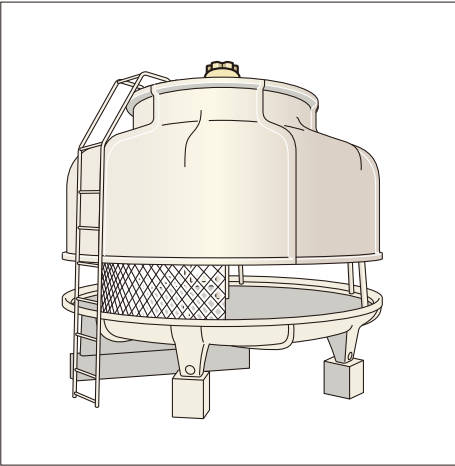

- Motor capacity and Inverter capacity
 - Motor capacity : 5.5 (kW)
 - Inverter model : FRN5.5F1S-2 (FRENIC-Eco)
 - DC REACTOR : DCR2-5.5
- Power reduction rate and energy saving effect amount

Item	Operation using commercial power	Inverter-controlled operation		
		45	40	35
Operation frequency (Hz)	60	45	40	35
Average power use (kW)	5.18	2.31	1.63	1.10
Power reduction rate (%)	-	▲55.4	▲68.5	▲78.8
Annual power charge (yen)	410,256	182,952	129,096	87,120
Annual amount (yen) of energy savings effect	-	227,304	281,160	323,136
Annual CO ₂ reduction volume (kg/year)	-	9,557	11,822	13,586

- Operating conditions
 - Annual operating days : 300 (days/year)
 - Working hours per day : 20 (hrs/day)
 - Power charge unit price : 13.2 (yen/kWh)

■ Mist collector (generating variable torque load)

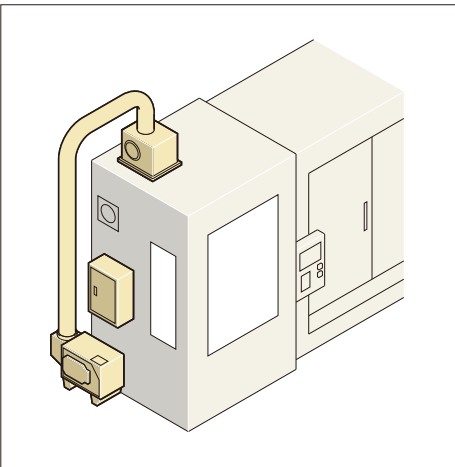

- Motor capacity and Inverter capacity
 - Motor capacity : 3.7 (kW)
 - Inverter Model : FRN3.7F1S-2 (FRENIC-Eco)
 - DC REACTOR : DCR2-3.7
- Power reduction rate and energy saving effect amount

Item	Operation using commercial power	Inverter-controlled operation		
		45	40	35
Operation frequency (Hz)	60	45	40	35
Average power use (kW)	3.27	1.44	0.99	0.69
Power reduction rate (%)	-	▲56.0	▲69.7	▲78.9
Annual power charge (yen)	260,161	114,566	78,764	54,896
Annual amount (yen) of energy savings effect	-	145,595	181,397	205,265
Annual CO ₂ reduction volume (kg/year)	-	5,281	6,580	7,446

- Operating conditions
 - Annual operating days : 260 (days/year)
 - Working hours per day : 20 (hrs/day)
 - Power charge unit price : 15.3 (yen/kWh)

Conduct a search. You can study energy savings with the following types of equipment.



- Air conditioning fans • AHU
- Dust collectors • Mist -collectors
- Exhaust fans • Package air conditioners, etc.



- Cooling water pumps
- Circulating pumps
- Cleaning pump
- Roots blowers
- Coolant pumps
- Water cooler pumps, etc.



Standard specifications

■ Three-phase 200V series

Item		Specifications																
Type (FRN□□□F1S-2A)		0.75	1.5	2.2	3.7	5.5	7.5	11	15	18.5	22	30	37	45	55	75	90	110
Nominal applied motor (kW) *1		0.75	1.5	2.2	3.7	5.5	7.5	11	15	18.5	22	30	37	45	55	75	90	110
Output ratings	Rated capacity (kVA) *2	1.6	2.6	4.0	6.3	9.0	12	17	22	27	32	43	53	64	80	105	122	148
	Rated voltage (V) *3	Three-phase, 200 to 240V (With AVR function)																
	Rated current (A) *4, *10	4.2	7.0	10.6	16.7	23.8	31.8	45	58	73	85	114	140	170	211	276	322	390
	Overload capability	120% of rated current for 1min																
	Rated frequency	50, 60 Hz																
Input ratings	Phases, voltage, frequency	Main power supply	Three-phase, 200 to 240V, 50/60Hz										Three-phase, 200 to 220V/50Hz Three-phase, 200 to 230V/60Hz					
		Auxiliary control power input	Single-phase, 200 to 240V, 50/60Hz for the terminals										Single-phase, 200 to 220V/50Hz Single-phase, 200 to 230V/60Hz					
		Auxiliary fan power input *9	—										Single-phase, 200 to 220V/50Hz Single-phase, 200 to 230V/60Hz					
	Voltage/frequency variations		Voltage: +10 to -15% (Voltage unbalance: 2% or less) *7, Frequency: +5 to -5%															
	Rated current (A) *8	(with DCR)	3.2	6.1	8.9	15.0	21.1	28.8	42.2	57.6	71.0	84.4	114	138	167	203	282	334
(without DCR)		5.3	9.5	13.2	22.2	31.5	42.7	60.7	80.1	97.0	112	151	185	225	270	—	—	—
Required power supply capacity (kVA) *5		1.2	2.2	3.1	5.3	7.4	10	15	20	25	30	40	48	58	71	98	116	142
Braking	Torque (%) *6	20										10 to 15						
	DC injection braking	Starting frequency: 0.0 to 60.0Hz, Braking time: 0.0 to 30.0s, Braking level: 0 to 60%																
DC reactor (DCR)		Option												Standard				
Applicable safety standards		UL508C, C22.2 No.14, EN50178:1997 (Applying)																
Enclosure (IEC60529)		IP20, UL open type										IP00, UL open type						
Cooling method		Natural cooling				Fan cooling												
Mass (kg)		3.1	3.2	3.3	3.4	3.4	5.8	6.0	6.9	9.5	9.7	11.5	23	33	34	41	75	120

*1 Fuji 4-pole standard motor

*2 Rated capacity is calculated by assuming the output rated voltage as 220V for three-phase 200V series.

*3 Output voltage cannot exceed the power supply voltage.

*4 An excessively low setting of the carrier frequency may result in the higher motor temperature or tripping of the inverter by its overcurrent limiter setting. Lower the continuous load or maximum load instead. (When setting the carrier frequency (F26) to 1kHz, reduce the load to 80% of its rating.)

*5 Obtained when a DC reactor (DCR) is used.

*6 Average braking torque (Varies with the efficiency of the motor.)

*7 Voltage unbalance (%) = $\frac{\text{Max. voltage (V)} - \text{Min. voltage (V)}}{\text{Three-phase average voltage (V)}} \times 67$ (IEC61800-3 (5.2.3))

If this value is 2 to 3%, use an AC reactor (ACR option).

*8 Trial calculation done on assumption that the power capacity is 500kVA (or 10 times the inverter capacity if the inverter capacity is larger than 50kVA) and the inverter is connected to the power supply of %X=5%.

*9 Use [R1, T1] terminals for driving AC cooling fans of an inverter powered by the DC link bus, such as by a high power factor PWM converter. (In ordinary operation, the terminals are not used.)

*10 When using the inverter at an ambient temperature higher than 40°C and at a carrier frequency of 3kHz or over, select the inverter so that the current does not exceed the rated current specified in () during continuous operation.

■ Three-phase 400V series

● 0.75 to 55kW

Item		Specifications													
Type (FRN□□□F1S-4A)		0.75	1.5	2.2	3.7	5.5	7.5	11	15	18.5	22	30	37	45	55
Nominal applied motor (kW) *1		0.75	1.5	2.2	3.7	5.5	7.5	11	15	18.5	22	30	37	45	55
Output ratings	Rated capacity (kVA) *2	1.9	2.8	4.1	6.8	9.5	12	17	22	28	33	44	54	64	77
	Rated voltage (V) *3	Three-phase, 380 to 480V (with AVR function)													
	Rated current (A) *4	2.5	3.7	5.5	9.0	12.5	16.5	23	30	37	44	59	72	85	105
	Overload capability	120% of rated current for 1min													
	Rated frequency	50, 60 Hz													
Input ratings	Phases, voltage, frequency	Main power supply	Three-phase, 380 to 480V, 50/60Hz											Three-phase, 380 to 440V/50Hz Three-phase, 380 to 480V/60Hz	
		Auxiliary control power input	Single-phase, 380 to 480V, 50/60Hz											Single-phase, 380 to 440V/50Hz Single-phase, 380 to 480V/60Hz	
		Auxiliary fan power input *9	—											*10	
	Voltage/frequency allowance	Voltage: +10 to -15% (Voltage unbalance: 2% or less) *7, Frequency: +5 to -5%													
	Rated current (A) *8	(with DCR)	1.6	3.0	4.5	7.5	10.6	14.4	21.1	28.8	35.5	42.2	57.0	68.5	83.2
	(without DCR)	3.1	5.9	8.2	13.0	17.3	23.2	33.0	43.8	52.3	60.6	77.9	94.3	114	140
Required power supply capacity (kVA) *5		1.2	2.2	3.1	5.3	7.4	10	15	20	25	30	40	48	58	71
Braking	Torque (%) *6	20							10 to 15						
	DC injection braking	Starting frequency: 0.0 to 60.0Hz, Braking time: 0.0 to 30.0s, Braking level: 0 to 60%													
DC reactor (DCR)		Option													
Applicable safety standards		UL508C, C22.2 No.14, EN50178:1997 (Applying)													
Enclosure (IEC60529)		IP20, UL open type										IP00, UL open type			
Cooling method		Natural cooling							Fan cooling						
Mass (kg)		3.1	3.2	3.3	3.4	3.4	5.8	6.0	6.9	9.4	9.9	11.5	23	24	33

● 75 to 560kW

Item		Specifications													
Type (FRN□□□F1S-4A)		75	90	110	132	160	200	220	280	315	355	400	450	500	560
Nominal applied motor (kW) *1		75	90	110	132	160	200	220	280	315	355	400	450	500	560
Output ratings	Rated capacity (kVA) *2	105	128	154	182	221	274	316	396	445	495	563	640	731	792
	Rated voltage (V) *3	Three-phase, 380 to 480V (with AVR function)													
	Rated current (A) *4	139	168	203	240	290	360	415	520	585	650	740	840	960	1040
	Overload capability	120% of rated current for 1min													
	Rated frequency	50, 60 Hz													
Input ratings	Phases, voltage, frequency	Main power supply	Three-phase, 380 to 440V, 50Hz or Three-phase, 380 to 480V, 60Hz												
		Auxiliary control power input	Single-phase, 380 to 480V, 50/60Hz												
		Auxiliary fan power input *9	Single-phase, 380 to 440V/50Hz Single-phase, 380 to 480V/60Hz												
	Voltage/frequency variations	Voltage: +10 to -15% (Voltage unbalance: 2% or less) *7, Frequency: +5 to -5%													
	Rated current (A) *8	(with DCR)	138	164	201	238	286	357	390	500	559	628	705	789	881
	(without DCR)	—	—	—	—	—	—	—	—	—	—	—	—	—	—
Required power supply capacity (kVA) *5		96	114	140	165	199	248	271	347	388	435	489	547	611	686
Braking	Torque (%) *6	10 to 15													
	DC injection braking	Starting frequency: 0.0 to 60.0Hz, Braking time: 0.0 to 30.0s, Braking level: 0 to 60%													
DC reactor (DCR)		Option													
Applicable safety standards		UL508C, C22.2 No.14, EN50178:1997 (Applying)													
Enclosure (IEC60529)		IP00, UL open type													
Cooling method		Fan cooling													
Mass (kg)		34	42	45	63	67	96	98	162	165	282	286	355	360	360

*1 Fuji 4-pole standard motor

*2 Rated capacity is calculated by assuming the output rated voltage as 440V for three-phase 400 V series.

*3 Output voltage cannot exceed the power supply voltage.

*4 An excessively low setting of the carrier frequency may result in the higher motor temperature or tripping of the inverter by its overcurrent limiter setting. Lower the continuous load or maximum load instead. (When setting the carrier frequency (F26) to 1kHz, reduce the load to 80% of its rating.)

*5 Obtained when a DC reactor (DCR) is used.

*6 Average braking torque (Varies with the efficiency of the motor.)

*7 Voltage unbalance (%) = $\frac{\text{Max. voltage (V)} - \text{Min. voltage (V)}}{\text{Three-phase average voltage (V)}} \times 67$ (IEC61800-3)

If this value is 2 to 3%, use an AC reactor (ACR option).

*8 Trial calculation done on assumption that the power capacity is 500kVA (or 10 times the inverter capacity if the inverter capacity is larger than 50kVA) and the inverter is connected to the power supply of %X=5%.

*9 Use [R1, T1] terminals for driving AC cooling fans of an inverter powered by the DC link bus, such as by a high power factor PWM converter. (In ordinary operation, the terminals are not used.)

*10 Single-phase, 380 to 440V/50Hz or Single-phase, 380 to 480V/60Hz



Semi-standard specifications Built-in DC reactor series

Three-phase 200V series

Item		Specifications															
Type (FRN□□□F1H-2A)		0.75	1.5	2.2	3.7	5.5	7.5	11	15	18.5	22	30	37	45	55	75	
Applicable motor rating [kW]		*1	0.75	1.5	2.2	3.7	5.5	7.5	11	15	18.5	22	30	37	45	55	75
Output ratings	Rated capacity [kVA]	*2	1.6	2.6	4.0	6.3	9.0	12	17	22	27	32	43	53	64	80	105
	Voltage [V]	*3	Three-phase 200 to 240V (with AVR function)														
	Rated current [A]	*4 *9	4.2	7.0	10.6	16.7	23.8 (22.5)	31.8 (29)	45 (42)	58 (55)	73 (68)	85 (80)	114 (107)	140 (130)	170 (156)	211 (198)	276 (270)
	Overload capability		120% of rated current for 1min														
	Rated frequency [Hz]		50, 60Hz														
Input ratings	Phases, voltage, frequency	Main power supply	Three-phase, 200 to 240V, 50/60Hz										Three-phase, 200 to 220V/50Hz Three-phase, 200 to 230V/60Hz				
		Auxiliary control power input	Single-phase, 200 to 240V, 50/60Hz										Single-phase, 200 to 220V/50Hz Single-phase, 200 to 230V/60Hz				
		Auxiliary fan power input *8	—										Single-phase, 200 to 220V/50Hz Single-phase, 200 to 230V/60Hz				
	Voltage/frequency variations		Voltage: +10 to -15% (Voltage unbalance: 2% or less *7), Frequency: +5 to -5%														
	Rated input current [A]	*5	3.2	6.1	8.9	15.0	21.1	28.8	42.2	57.6	71.0	84.4	114	138	167	203	282
Required power supply capacity [kVA]		1.2	2.2	3.1	5.3	7.4	10	15	20	25	30	40	48	58	71	98	
Braking	Braking torque [%]	*6	20										10 to 15				
	DC injection braking		Starting frequency: 0.0 to 60.0Hz, Braking time: 0.0 to 30.0s, Braking level: 0 to 60%														
Reactor unit	DC REACTOR		Provided (If load of 100% is used (rated output) used, power supply ratio is above 86%.)														
	Zero-phase reactor		Provided (for radio noise reduction)										Not provided				
	Capacitive filter		Provided (removable)										Not provided				
Applicable safety standards			UL508C, C22.2No.14, EN50178: 1997 (Approval pending)														
Enclosure (IEC60529)			IP20, UL open type										IP20, UL type1 (NEMA1)				
Cooling method			Natural cooling					Fan cooling									
Weight / Mass [kg]			5.9	6.2	6.6	6.7	6.9	12.7	13.6	15.3	18.7	19.5	23	39	52	55	63

Three-phase 400V series

Item		Specifications															
Type (FRN□□□F1H-4A)		0.75	1.5	2.2	3.7	5.5	7.5	11	15	18.5	22	30	37	45	55	75	
Applicable motor rating [kW]		*1	0.75	1.5	2.2	3.7	5.5	7.5	11	15	18.5	22	30	37	45	55	75
Output ratings	Rated capacity [kVA]	*2	1.9	2.8	4.0	6.8	9.5	12	17	22	28	33	44	54	64	80	105
	Voltage [V]	*3	Three-phase 380 to 480V (with AVR function)														
	Rated current [A]	*4	2.5	3.7	5.5	9.0	12.5	16.5	23	30	37	44	59	72	85	105	139
	Overload capability		120% of rated current for 1min														
	Rated frequency [Hz]		50, 60Hz														
Input ratings	Phases, voltage, frequency	Main power supply	Three-phase, 380 to 480V, 50/60Hz										Three-phase, 380 to 440V/50Hz Three-phase, 380 to 480V/60Hz				
		Auxiliary control power input	Single-phase, 380 to 480V, 50/60Hz										Single-phase, 380 to 440V/50Hz Single-phase, 380 to 480V/60Hz				
		Auxiliary fan power input *8	—										Single-phase, 380 to 440V/50Hz Single-phase, 380 to 480V/60Hz				
	Voltage/frequency variations		Voltage: +10 to -15% (Voltage unbalance: 2% or less *7), Frequency: +5 to -5%														
	Rated input current [A]	*5	1.6	3.0	4.5	7.5	10.6	14.4	21.1	28.8	35.5	42.2	57.0	68.5	83.2	102	138
Required power supply capacity [kVA]		1.2	2.2	3.1	5.3	7.4	10	15	20	25	30	40	48	58	71	96	
Braking	Braking torque [%]	*6	20										10 to 15				
	DC injection braking		Starting frequency: 0.0 to 60.0Hz, Braking time: 0.0 to 30.0s, Braking level: 0 to 60%														
Reactor unit	DC REACTOR		Provided (If load of 100% is used (rated output) used, power supply ratio is above 86%.)														
	Zero phase reactor		Provided (for radio noise reduction)										Not provided				
	Capacitive filter		Provided (removable)										Not provided				
Applicable safety standards			UL508C, C22.2No.14, EN50178: 1997 (Approval pending)														
Enclosure (IEC60529)			IP20, UL open type										IP20, UL type1 (NEMA1)				
Cooling method			Natural cooling					Fan cooling									
Weight / Mass [kg]			5.9	6.2	6.4	6.8	6.8	13.5	13.5	15.0	19.4	20	23	39	41	54	57

*1 Fuji's 4-pole standard motor

*2 Rated capacity is calculated by assuming the output rated voltage as 220V for three-phase 200V series and 440V for three-phase 400V series.

*3 Output voltage cannot exceed the power supply voltage.

*4 When the carrier frequency is low, the temperature of the motor may increase rapidly or the inverter protection (current limit) may activate.

When setting the carrier frequency to 1kHz or less, reduce the load to 80% of its rated value.

*5 The value is calculated on assumption that the inverter is connected with a power supply capacity of 500kVA (or 10 times the inverter capacity if the inverter capacity exceeds 50kVA) and %X is 5%.

*6 Average braking torque without optional braking resistor (Varies with the efficiency of the motor.)

*7 Voltage unbalance [%] = $\frac{\text{Max. voltage [V]} - \text{Min. voltage [V]}}{\text{Three-phase average voltage [V]}} \times 67$ (compliant with IEC61800-3)

If this value is 2 to 3%, use an AC REACTOR (ACR option).

*8 It is used as an AC fan power supply input for applications combined with a high power-factor PWM converter with power regeneration function or the like (not used during normal operation).

*9 Use the inverter at the current given in () or below when the carrier frequency setting is higher than 3kHz or the ambient temperature is 40°C or higher.

Semi-standard specifications EMC filter built-in series

Three-phase 200V series

Item		Specifications									
Type (FRN□□□F1E-2A)		0.75	1.5	2.2	3.7	5.5	7.5	11	15		
Applicable motor rating [kW]		*1	0.75	1.5	2.2	3.7	5.5	7.5	11	15	
Rated capacity [kVA]		*2	1.6	2.6	4.0	6.3	9.0	12	17	22	
Output ratings	Voltage [V]		*3 Three-phase 200 to 240V (with AVR function)								
	Rated current [A]		*4 *8	4.2	7.0	10.6	16.7	23.8 (22.5)	31.8 (29)	45 (42)	58 (55)
	Overload capability		120% of rated current for 1min								
	Rated frequency [Hz]		50, 60Hz								
Input ratings	Phases, voltage, frequency	Main power supply	Three-phase, 200 to 240V, 50/60Hz								
		Auxiliary control power input	Single-phase, 200 to 240V, 50/60Hz								
	Voltage/frequency variations		Voltage: +10 to -15% (Voltage unbalance: 2% or less *7), Frequency: +5 to -5%								
	Rated input current [A]		*5	3.2	6.1	8.9	15.0	21.1	28.8	42.2	57.6
Required power supply capacity [kVA]			1.2	2.2	3.1	5.3	7.4	10	15	20	
Braking	Braking torque [%]		*6 20								
	DC injection braking		Starting frequency: 0.0 to 60.0Hz, Braking time: 0.0 to 30.0s, Braking level: 0 to 60%								
EMC filter unit	EMC filter		Provided (Compatible EMC standard: Emission, Immunity: 2nd Env. (EN61800-3: 1996+A11: 2000))								
	DC REACTOR		Provided (If load of 100% is used (rated output) used, power supply ratio is above 86%.)								
Applicable safety standards		UL508C, C22.2No.14, EN50178: 1997 (Approval pending)									
Enclosure (IEC60529)		IP20, UL type									
Cooling method		Natural cooling				Fan cooling					
Weight / Mass [kg]		6.0	6.3	6.7	6.8	7.0	13.9	14.6	15.4		

Three-phase 400V series

Item		Specifications									
Type (FRN□□□F1E-4A)		0.75	1.5	2.2	3.7	5.5	7.5	11	15		
Applicable motor rating [kW]		*1	0.75	1.5	2.2	3.7	5.5	7.5	11	15	
Rated capacity [kVA]		*2	1.9	2.8	4.1	6.8	9.5	12	17	22	
Output ratings	Voltage [V]		*3 Three-phase 200 to 240V (with AVR function)								
	Rated current [A]		*4	2.5	3.7	5.5	9.0	12.5	16.5	23	30
	Overload capability		120% of rated current for 1min								
	Rated frequency [Hz]		50, 60Hz								
Input ratings	Phases, voltage, frequency	Main power supply	Three-phase, 380 to 480V, 50/60Hz								
		Auxiliary control power input	Single-phase, 380 to 480V, 50/60Hz								
	Voltage/frequency variations		Voltage: +10 to -15% (Voltage unbalance: 2% or less *7), Frequency: +5 to -5%								
	Rated input current [A]		*5	1.6	3.0	4.5	7.5	10.6	14.4	21.1	28.8
Required power supply capacity [kVA]			1.2	2.2	3.1	5.3	7.4	10	15	20	
Braking	Braking torque [%]		*6 20								
	DC injection braking		Starting frequency: 0.0 to 60.0Hz, Braking time: 0.0 to 30.0s, Braking level: 0 to 60%								
EMC filter unit	EMC filter		Provided (According to the compatible EMC standard, emission corresponds to class A (NE55011: 1998+A1: 1999+ A2: 2002) and immunity corresponds to 2nd ENV. (EN61800-3: 1996+A11: 2000).)								
	DC REACTOR		Provided (Under 100% load of rated output, the power factor is 86% or over.)								
Applicable safety standards		UL508C, C22.2No.14, EN50178: 1997 (Approval pending)									
Enclosure (IEC60529)		IP20, UL type									
Cooling method		Natural cooling				Fan cooling					
Weight / Mass [kg]		6.0	6.3	6.5	6.9	6.9	14.8	14.5	15.2		

*1 Fuji's 4-pole standard motor

*2 Rated capacity is calculated by assuming the output rated voltage as 220V for three-phase 200V series and 440V for three-phase 400V series.

*3 Output voltage cannot exceed the power supply voltage.

*4 When the carrier frequency is low, the temperature of the motor may increase rapidly or the inverter protection (current limit) may activate.

When setting the carrier frequency to 1kHz or less, reduce the load to 80% of its rated value.

*5 The value is calculated on assumption that the inverter is connected with a power supply capacity of 500kVA (or 10 times the inverter capacity if the inverter capacity exceeds 50kVA) and %X is 5%.

*6 Average braking torque without optional braking resistor (Varies with the efficiency of the motor.)

*7 Voltage unbalance [%] = $\frac{\text{Max. voltage [V]} - \text{Min. voltage [V]}}{\text{Three-phase average voltage [V]}} \times 67$ (compliant with IEC61800-3)

If this value is 2 to 3%, use an AC REACTOR (ACR option).

*8 Use the inverter at the current given in () or below when the carrier frequency setting is higher than 3kHz or the ambient temperature is 40°C or higher.



Semi-standard specifications Waterproof (IP54) series

Three-phase 200V series

Item		Specifications														
Type (FRN□□□F1L/D-2A)		0.75	1.5	2.2	3.7	5.5	7.5	11	15	18.5	22	30	37	45		
Applicable motor rating [kW]		*1	0.75	1.5	2.2	3.7	5.5	7.5	11	15	18.5	22	30	37	45	
Output ratings	Rated capacity [kVA]	*2	1.6	2.6	4.0	6.3	9.0	12	17	22	27	32	43	53	64	
	Voltage [V]	*3	Three-phase 200 to 240V (with AVR function)													
	Rated current [A]	*4 *9	4.2	7.0	10.6	16.7	23.8 (22.5)	31.8 (29)	45 (42)	58 (55)	73 (68)	85 (80)	114 (107)	140 (130)	170 (156)	
	Overload capability		120% of rated current for 1min													
	Rated frequency [Hz]		50, 60Hz													
Input ratings	Phases, voltage, frequency	Main power supply	Three-phase, 200 to 240V, 50/60Hz										Three-phase, 200 to 220V/50Hz Three-phase, 200 to 230V/60Hz			
		Auxiliary control power input	Single-phase, 200 to 240V, 50/60Hz										Single-phase, 200 to 220V/50Hz Single-phase, 200 to 230V/60Hz			
		Auxiliary fan power input *8	—										Single-phase, 200 to 220V/50Hz Single-phase, 200 to 230V/60Hz			
	Voltage/frequency variations		Voltage: +10 to -15% (Voltage unbalance: 2% or less *7), Frequency: +5 to -5%													
	Rated input current [A]	*5	5.3	9.5	13.2	22.2	31.5	42.7	60.7	80.1	97.0	112	151	185	225	
Required power supply capacity [kVA]		1.9	3.3	4.6	7.7	11	15	22	28	34	39	53	65	78		
Braking	Braking torque [%]	*6	20									10 to 15				
	DC injection braking		Starting frequency: 0.0 to 60.0Hz, Braking time: 0.0 to 30.0s, Braking level: 0 to 60%													
Applicable safety standards			UL508C, C22.2No.14, EN50178: 1997 (Approval pending)													
Enclosure			IP54 (IEC60529)/UL TYPE12 (UL50)													
Cooling method			Natural cooling					Fan cooling								
Weight / Mass [kg]			11	11	12	12	12	18	18	19	27	27	29	47	63	

Three-phase 400V series

Item		Specifications																	
Type (FRN□□□F1L/D-4A)		0.75	1.5	2.2	3.7	5.5	7.5	11	15	18.5	22	30	37	45	55	75	90		
Applicable motor rating [kW]		*1	0.75	1.5	2.2	3.7	5.5	7.5	11	15	18.5	22	30	37	45	55	75	90	
Output ratings	Rated capacity [kVA]	*2	1.9	2.8	4.1	6.8	9.5	12	17	22	28	33	44	54	64	80	105	128	
	Voltage [V]	*3	Three-phase 380 to 480V (with AVR function)																
	Rated current [A]	*4	2.5	3.7	5.5	9.0	12.5	16.5	23	30	37	44	59	72	85	105	139	168	
	Overload capability		120% of rated current for 1min																
	Rated frequency [Hz]		50, 60Hz																
Input ratings	Phases, voltage, frequency	Main power supply	Three-phase, 380 to 480V, 50/60Hz										Three-phase, 380 to 440V/50Hz Three-phase, 380 to 480V/60Hz						
		Auxiliary control power input	Single-phase, 380 to 480V, 50/60Hz										Single-phase, 380 to 440V/50Hz Single-phase, 380 to 480V/60Hz						
		Auxiliary fan power input *8	—										Single-phase, 380 to 440V/50Hz Single-phase, 380 to 480V/60Hz						
	Voltage/frequency variations		Voltage: +10 to -15% (Voltage unbalance: 2% or less *7), Frequency: +5 to -5%																
	Rated input current [A]	*5	Built-in DCR		—														
		Without DCR		3.1	5.9	8.2	13.0	17.3	23.2	33.0	43.8	52.3	60.6	77.9	94.3	114	140	—	—
Required power supply capacity [kVA]		2.2	4.1	5.7	9.1	12	17	23	31	37	42	54	66	79	97	96	114		
Braking	Braking torque [%]	*6	20									10 to 15							
	DC injection braking		Starting frequency: 0.0 to 60.0Hz, Braking time: 0.0 to 30.0s, Braking level: 0 to 60%																
Applicable safety standards			UL508C, C22.2No.14, EN50178: 1997 (Approval pending)																
Enclosure			IP54 (IEC60529)/UL TYPE12 (UL50)																
Cooling method			Natural cooling					Fan cooling											
Weight / Mass [kg]			11	11	12	12	12	18	18	19	27	27	29	47	47	63	75	87	

*1 Fuji's 4-pole standard motor

*2 Rated capacity is calculated by assuming the output rated voltage as 220V for three-phase 200V series and 440V for three-phase 400V series.

*3 Output voltage cannot exceed the power supply voltage.

*4 When the carrier frequency is low, the temperature of the motor may increase rapidly or the inverter protection (current limit) may activate.

When setting the carrier frequency to 1kHz or less, reduce the load to 80% of its rated value.

*5 The value is calculated on assumption that the inverter is connected with a power supply capacity of 500kVA (or 10 times the inverter capacity if the inverter capacity exceeds 50kVA) and %X is 5%.

*6 Average braking torque without optional braking resistor (Varies with the efficiency of the motor.)











*7 Voltage unbalance [%] = $\frac{\text{Max. voltage [V]} - \text{Min. voltage [V]}}{\text{Three-phase average voltage [V]}} \times 67$ (compliant with IEC61800-3)

If this value is 2 to 3%, use an AC REACTOR (ACR option).

*8 It is used as an AC fan power supply input for applications combined with a high power-factor PWM converter with power regeneration function or the like (not used during normal operation).

*9 Use the inverter at the current given in () or below when the carrier frequency setting is higher than 3kHz or the ambient temperature is 30°C or higher.

Common specifications

Item		Explanation	Remarks	Related function code	
Output frequency	Setting range				
	Maximum frequency	25 to 120Hz		F03	
	Base frequency	25 to 120Hz		F04	
	Starting frequency	0.1 to 60.0Hz		F23	
	Carrier frequency	<ul style="list-style-type: none"> 0.75 to 15kHz (200V/400V: 0.75 to 22kW) 0.75 to 10kHz (200V/400V: 30 to 75kW) 0.75 to 6kHz (200V/400V: 90 to 560kW) 0.75 to 4kHz (200V/400V: 37 to 90kW, IP54 series) 	The carrier frequency may drop automatically according to the ambient temperature or output current to protect the inverter. This protective operation can be canceled by function code H98.	F26, F27, H98	
	Accuracy (Stability)	<ul style="list-style-type: none"> Analog setting: Less than $\pm 0.2\%$ of maximum frequency (at $25\pm 10^\circ\text{C}$) Keypad setting: Less than $\pm 0.01\%$ of maximum frequency (at -10 to $+50^\circ\text{C}$) 			
Setting resolution	<ul style="list-style-type: none"> Analog setting: 1/1000 of maximum frequency (ex. 0.06Hz at 60Hz, 0.12Hz at 120Hz) Keypad setting: 0.01Hz (99.99Hz or less), 0.1Hz (100.0Hz or more) Link setting: Selectable from 2 types <ul style="list-style-type: none"> 1/20000 of maximum frequency (ex. 0.003Hz at 60Hz, 0.006Hz at 120Hz) 0.01Hz (fixed) 	Setting with  and  keys			
Control	Control method	V/f control			
	Voltage/freq. characteristic (Polygonal line)	Possible to set output voltage at base frequency and at maximum output frequency (common spec.). AVR control can be turned ON or OFF. 1 point (Arbitrary voltage and frequency can be set.)	Three-phase 200V: 80 to 240V Three-phase 400V: 160 to 500V Three-phase 200V: 0 to 240V/0 to 120Hz Three-phase 400V: 0 to 500V/0 to 120Hz	F03 to F05 H50, H51	
	Torque boost (Load selection)	Torque boost can be set with the function code F09. Select application load type with the function code F37. 0: Variable torque load 1: Variable torque load (for high starting torque) 2: Auto-torque boost 3: Auto-energy-saving operation (variable torque load in acceleration/deceleration) 4: Auto-energy-saving operation (variable torque load (for high starting torque) for acceleration/deceleration) 5: Auto-energy-saving operation (auto-torque boost in acceleration/deceleration)	Set when 0, 1, 3, or 4 is selected at F37.	F09, F37 F09, F37	
	Starting torque	50% or over			
	Start/stop	Keypad operation	Start (FWD/REV) and stop with  and  keys.	Keypad (standard)	F02
			Start and stop with  ,  and  keys.	Multi-function keypad (Option)	F02
		External signals : Forward (reverse) rotation, stop command (capable of 3-wire operation), (7 digital inputs) second operation command, coast-to-stop command, external alarm, alarm reset, etc.			E01 to E05 E98, E99
		Link operation: Operation through RS-485 communication and Field Bus communication (option)			H30, y98
	Frequency setting	Operation command switching: Remote/local switch, link switch, second operation command switch			
		Keypad operation	Can be set with  ,  keys.		F01, C30
			External potentiometer: Can be set with the external variable resistor (1 to 5k Ω , 1/2W)	Connected to the analog input terminals 13, 12, and 11. A separate variable resistor is necessary.	
		Analog input	Can be set with external voltage/current input. 0 to +10V DC (0 to +5V DC)/0 to 100% (terminal 12, V2) 4 to 20mA DC/0 to 100% (terminal C1)	0 to +5V DC: Change (200%) in analog input gain setting. +1 to +5V DC: Adjustable with bias/analog input gain	F18, C50, C32 to C34, C37 to C39, C42 to C44
			Multistep frequency : Selectable from 8 steps (step 0 to 7)		C05 to C11
		UP/DOWN operation : The frequency rises or lowers while the digital input signal is turned on.		F01, C30	
		Link operation : Can be set with RS485 communications and field bus communications (option).		H30, y98	
		Frequency setting change : Two types of frequency settings can be switched with an external signal (digital input). Changeover between remote and local (keypad operation) or frequency setup through communication is also possible.		F01, C30	
		Auxiliary frequency setting : Inputs at terminal 12, C1 or V2 can be added to the main setting as auxiliary frequency settings.		E61 to E63	
		Inverse operation : The digital input signal and function code setting sets or switches between the normal and inverse actions. • +10 to 0V DC/0 to 100% (Terminal 12, V2) • 20 to 4mA DC/0 to 100% (Terminal C1)		C53	
	Acceleration/ deceleration time	0 to 3600s • Acceleration and deceleration pattern can be selected from 4 types: Linear, S-curve (weak), S-curve (strong), Non-linear (constant output max. capacity). • Shutoff of the operation command coasts the motor to decelerate and stop.		F07, F08 H07 H11	
	Frequency limiter	High and low limiters can be set (setting range: 0 to 120Hz)	Selection can be made between continuation of operation and stopping at frequencies equal to or smaller than the lower limit.	F15, F16 H63	
Bias frequency	Bias of set frequency and PID command can be set in the range between 0 and $\pm 100\%$.		F18, C50 to C52		
Gain for frequency setting	The analog input gain can be set in the range from 0 to 200%.	Voltage signals (terminal 12, V2) and current signal (terminal C1) can be set independently.	C32, C34, C37, C39, C42, C44		
Jump frequency setting	Three operation points and the jump width (0 to 30Hz) common to the three points can be set.		C01 to C04		
Restart after momentary power failure	<ul style="list-style-type: none"> The inverter restarts upon recovery from power failure without stopping the motor. In the "operation continuation mode," recovery of the power supply is waited for while the output frequency slightly drops. Selection can be made among starting at 0Hz, starting at the frequency immediately before the momentary power failure, and starting at a set frequency for the starting method after power recovery. 		F14 H13 to H16, H92, H93		
Current limit	Keeps the current under the preset value during operation.		F43, F44		
Line/inverter switching	<ul style="list-style-type: none"> Line/inverter switching (starting at line frequency) can be made with a digital input signal (SW50, SW60). A built-in line/inverter switching sequence performs sequence control with a digital input signal (ISW50, ISW60) to output a signal (SW88, SW52-1, SW52-2) for controlling an external magnetic contactor (MC). As a built-in sequence, two types can be selected, including the one switching automatically to the line upon an inverter alarm. 		J22		
PID control	Capable of PID regulator control for process			E61 to E63	
	<ul style="list-style-type: none"> Process commands Key operation ( and  keys): 0 to 100% Analog input (terminal 12, V2): 0 to +10V DC/0 to 100% Analog input (terminal C1): 4 to 20mA DC/0 to 100% UP/DOWN (digital input): 0 to 100% Communication (RS485, bus option): 0 to 20,000/0 to 100% 			J01 to J06 J10 to J19	





Common specifications

Item	Explanation	Remarks	Related function code		
Control	PID control	<ul style="list-style-type: none"> ■ Feedback value • Analog input (terminal 12, V2) : 0 to +10V DC/0 to 100% • Analog input (terminal C1) : 4 to 20mA DC/0 to 100% ■ Incidental functions • Alarm output (absolute value alarm, deviation alarm) • Small water flow stoppage function • PID output limiter • Normal operation/inverse operation • Anti-reset wind-up function • Integration reset/hold 		E61 to E63, J01 to J06, J10 to J19	
	Pick-up	Operation begins at a preset pick-up frequency to search for the motor speed to start an idling motor without stopping it.		H09, H13, H17	
	Automatic deceleration	Upon a DC link voltage exceeding the overvoltage limit level during deceleration, the deceleration time automatically extends to avoid an OU trip.		H69, F08	
	Deceleration characteristic	The motor loss increases during deceleration to reduce the load energy regenerating at the inverter to avoid an OU trip upon mode selection.		H71	
	Automatic energy-savin operation	The output voltage is controlled to minimize the total sum of the motor loss and inverter loss at a constant speed.		F37, F09	
	Active drive	The output frequency is automatically reduced to suppress the overload protection trip of the inverter caused by an increase in the ambient temperature, operation frequency, motor load or the like.		H70	
	Auto-tuning	The motor parameters are automatically tuned.		P04	
	Cooling fan ON/OFF control	Detects inverter internal temperature and stops cooling fan when the temperature is low.	An external output is issued in a transistor output signal.	H06	
Indication	Running/stopping	<ul style="list-style-type: none"> • Speed monitor, output current [A], output voltage [V], torque calculation value, input power [kW], PID reference value, PID feedback value, PID output, load factor, motor output ◆ Select the speed monitor to be displayed from the following. Output frequency [Hz], motor speed [r/min.], load shaft speed [r/min.], % indication 		E43 E48	
	Life early warning	The life early warning of the main circuit capacitors, capacitors on the PC boards and the cooling fan can be displayed.	An external output is issued in a transistor output signal.		
	Cumulative run hours	The cumulative motor running hours, cumulative inverter running hours and cumulative watt-hours can be displayed.			
	Trip mode	Displays the cause of trip by codes.			
	Running or trip mode	Trip history: Saves and displays the last 4 trip codes and their detailed description.		E52	
Protection	Overcurrent protection	The inverter is stopped upon an overcurrent caused by an overload.			
	Short-circuit protection	The inverter is stopped upon an overcurrent caused by a short-circuit in the output circuit.			
	Grounding fault protection	The inverter is stopped upon an overcurrent caused by a grounding fault in the output circuit.			
	Overvoltage protection	An excessive DC link circuit voltage is detected to stop the inverter.	3-phase 200V / 400VDC 3-phase 400V / 800VDC		
	Surge protection	The inverter is protected against surge voltages intruding across the main circuit power cable and ground.			
	Undervoltage	Stops the inverter by detecting voltage drop in DC link circuit.	3-phase 200V / 200VDC 3-phase 400V / 400VDC	F14	
	Input phase loss	Stops or protects the inverter against input phase loss.	The protective function can be canceled with function code 98.	H98	
	Output phase loss	Detects breaks in inverter output wiring at the start of running and during running, stopping the inverter output.	The protective function can be canceled with function code 98.	H98	
	Overheating	The temperature of the heat sink of the inverter or that inside the inverter unit is detected to stop the inverter, upon a failure or overload of the cooling fan.		H43	
	Overload	The inverter is stopped upon the temperature of the heat sink of the inverter or the temperature of the switching element calculated from the output current.			
	Motor protection	Electronic thermal	The inverter is stopped upon an electronic thermal function setting to protect the motor.	Thermal time constant can be adjusted (0.5 to 75.0min.)	F10 to F12, P99
		PTC thermistor	A PTC thermistor input stops the inverter to protect the motor.		H26, H27
		Overload early warning	Warning signal can be output based on the set level before the inverter trips.		F10, F12, E34, E35, P99
	Stall prevention	The output frequency decreases upon an output current exceeding the limit during acceleration or constant speed operation, to avoid overcurrent trip.		H12	
	Momentary power failure protection	<ul style="list-style-type: none"> • A protective function (inverter stoppage) is activated upon a momentary power failure for 15msec or longer. • If restart upon momentary power failure is selected, the inverter restarts upon recovery of the voltage within the set time. 		H13 to H16, F14	
Retry function	When the motor is tripped and stopped, this function automatically resets the tripping state and restarts operation.	Waiting time before resetting and the number of retry times can be set.	H04, H05		
Command loss detection	A loss (broken wire, etc.) of the frequency command is detected to output an alarm and continue operation at the preset frequency (set at a ratio to the frequency before detection)		E65		
Environment	Installation location	Shall be free from corrosive gases, flammable gases, oil mist, dusts, and direct sunlight. [Pollution degree 2 (IEC60664-1)] Indoor use only.			
	Ambient temperature	-10 to +50 °C -10 to +40 °C (IP54 series)	-10 to 40 °C when inverters are installed side-by-side without clearance.		
	5 to 95% (nocondensation)	5 to 95% (no condensation)			
	Altitude	Altitude [m]	Output derating		* If the altitude exceeds 2,000m, insulate the interface circuit from the main power supply to conform to the Low Voltage Directives.
		Lower than 1,000	None		
		1001 to 2000	Decreases		
2001 to 3000		Decreases*			
Vibration	[Smaller than 75kW] 3mm (vibration width) : 2 to less than 9Hz, 9.8m/s ² : 9 to less than 20Hz, 2m/s ² : 20 to less than 55Hz, 1m/s ² : 55 to less than 200Hz	[90kW or more] 3mm (vibration width) : 2 to less than 9Hz, 2m/s ² : 9 to less than 55Hz, 1m/s ² : 55 to less than 200Hz	[IP54 series] 3mm (vibration width) : 2 to less than 9Hz, 2m/s ² : 9 to less than 55Hz, 1m/s ² : 55 to less than 200Hz		
Storage	Amb. temp	-25 to +65 °C			
	Amb. humidity	5 to 95%RH (no condensation)			

Protective Functions

Specifications

Protective Functions

Function	Description	LED indication	Alarm output (30A, B, C) Note	Related function code
Overcurrent protection	The inverter is stopped for protection against overcurrent.	During acceleration <i>OC1</i>	○	
Short circuit protection	The inverter is stopped for protection against overcurrent caused by a short-circuit in the output circuit.	During deceleration <i>OC2</i>		
Grounding fault protection	The inverter is stopped upon start-up for protection against overcurrent caused by a grounding fault in the output circuit. If the power supply is turned on with the grounding fault, the protection may be invalidated. (3-phase 200V 75kW or less, 3-phase 400V 220kW or less)	During constant speed operation <i>OC3</i>		
	The inverter is stopped upon detection of a zero-phase current on the output current and for protection against overcurrent caused by a grounding fault in the output circuit. (3-phase 200V 90kW or more, 3-phase 400V 280kW or more)	<i>EF</i>	○	
Overvoltage protection	An excessive voltage (3-phase 200V series: 400VDC, 3-phase 400V series: 800VDC) in the DC link circuit is detected and the inverter is stopped. If an excessive high input voltage is applied by mistake, the protection cannot be guaranteed.	During acceleration <i>OU1</i> During deceleration <i>OU2</i> During constant speed operation (when stopped) <i>OU3</i>	○	
Undervoltage protection	The voltage drop (3-phase 200V series: 200VDC, 3-phase 400V series: 400VDC) in the DC link circuit is detected to stop the inverter. However, when "F14: 3, 4 or 5" is selected, an alarm is not issued even upon a voltage drop in the DC link circuit.	<i>LU</i>	△	F14
Input phase loss protection	The input phase loss is detected to shut off the inverter output. This function protects the inverter from being damaged by adding extreme stress caused by a power phase loss or imbalance between phases. When the load to be connected is small or DC REACTOR is connected a phase loss is not detected.	<i>L in</i>	○	H98
Output phase loss protection	Detects breaks in inverter output wiring at the start of operation and during running, to shut off the inverter output.	<i>OPL</i>	○	H98
Overheating protection	Stops the inverter output upon detecting excess heat sink temperature in case of cooling fan failure or overload. Detects a failure (lock) of the internal circulation fan and stops the inverter (45kW or above in 200V series, 55kW or above in 400V series).	<i>OH1</i>	○	H43, H98
	The temperature inside the inverter unit in the event of cooling fan trouble and overload is detected to stop the inverter.	<i>OH3</i>	○	
Overload protection	The temperature inside the IGBT is calculated from the detection of output current and internal temperature, to shut off the inverter output.	<i>OLU</i>	○	
External alarm input	With the digital input signal (THR) opened, the inverter is stopped with an alarm.	<i>OH2</i>	○	E01 to E05 E98, E99
Fuse blown	The wiring breakage of the main circuit fuse in the inverter is detected to stop the inverter. (3-phase 200V 90kW or more, 3-phase 400V 90kW or more)	<i>FUS</i>	○	
Charging circuit fault	The charging circuit fault in the inverter is detected to stop the inverter. (3-phase 200V 45kW or more, 3-phase 400V 55kW or more)	<i>PbF</i>	○	
Motor protection	Electronic thermal The inverter is stopped with an electronic thermal function set to protect the motor. • The standard motor is protected at all the frequencies. • The inverter motor is protected at all the frequencies. * The operation level and thermal time constant can be set.	<i>OL1</i>	○	F10 F11, F12
	PTC thermistor A PTC thermistor input stops the inverter to protect the motor. • The PTC thermistor is connected between terminals V2 and 11 to set switches and function codes on the control PC board.	<i>OH4</i>	○	H26, H27
	Overload early warning Warning signal is output at the predetermined level before stopping the inverter with the electronic thermal function to protect the motor.	—	—	E34, E35
Stall prevention	This is protected when the instantaneous overcurrent limit works. • Instantaneous overcurrent limit: operates when the inverter output current goes beyond the instantaneous overcurrent limiting level, and avoids tripping (during acceleration and constant speed operation).	—	—	H12
Alarm relay output (for any fault)	The relay signal is output when the inverter stops upon an alarm. <Alarm reset> The  key or digital input signal (RST) is used to reset the alarm stop state. <Storage of alarm history and detailed data> Up to the last 4 alarms can be stored and displayed.	—	○	E20, E27 E01 to E05 E98, E99
Memory error	Data is checked upon power-on and data writing to detect any fault in the memory and to stop the inverter if any.	<i>Er1</i>	○	
Keypad communication error	The keypad (standard) or multi-function keypad (optional) is used to detect a communication fault between the keypad and inverter main body during operation and to stop the inverter.	<i>Er2</i>	○	F02
CPU error	Detects a CPU error or LSI error caused by noise.	<i>Er3</i>	○	
Option communication error	When each option card is used, a fault of communication with the inverter main body is detected to stop the inverter.	<i>Er4</i>		
Option error	When each option card is used, the option card detects a fault to stop the inverter.	<i>Er5</i>		
Operation error	STOP key priority Pressing the  key on the keypad or entering the digital input signal will forcibly decelerates and stops the motor even if the operation command through signal input or communication has been selected.	<i>Er6</i>	○	H96
	Start check If the operation command is entered in the following cases, <i>Er6</i> will be displayed on the LED monitor to prohibit operation. • Power-on • Alarm reset ( key ON) • The link operation selection "LE" is used to switch operation.			
Tuning error	When tuning failure, interruption, or any fault as a result of turning is detected while tuning for motor constant.	<i>Er7</i>	○	P04
RS-485 communication error	When the connection port of the keypad connected via RS-485 communication port to detects a communication error, the inverter is stopped and displays an error.	<i>Er8</i>	○	
Data save error upon undervoltage	When the undervoltage protection works, an error is displayed if data cannot be stored.	<i>ErF</i>	○	
RS-485 communication error (optional)	When an optional RS-485 communication card is used to configure the network, a fault of communication with the inverter main body is detected to stop the inverter.	<i>ErP</i>	○	
LSI error	When an error occurred in the LSI on the power supply printed circuit board, the inverter stops.	<i>ErH</i>	○	
Retry	When the motor is tripped and stopped, this function automatically resets the tripping state and restarts operation. (The number of retries and the length of wait before resetting can be set.)	—	—	H04, H05
Surge protection	The inverter is protected against surge voltage intruding between the main circuit power line and ground.	—	—	
Command loss detection	A loss (broken wire, etc.) of the frequency command is detected to output an alarm and continue operation at the preset frequency (set at a ratio to the frequency before detection).	—	—	E65
Momentary power failure protection	• A protective function (inverter stoppage) is activated upon a momentary power failure for 15msec or longer. • If restart upon momentary power failure is selected, the inverter restarts upon recovery of the voltage within the set time.	—	—	F14 H13 to H16
Active drive	The inverter output frequency is reduced to avoid tripping before heat sink overheating or tripping due to an overload (alarm indication: <i>OH1</i> or <i>OLU</i>).	—	—	H70

Note : The item indicated with △ in the alarm output (30A, B, C) column may not be issued according to some function code settings.



External Dimensions

Main body of standard inverter (5.5kW or smaller)

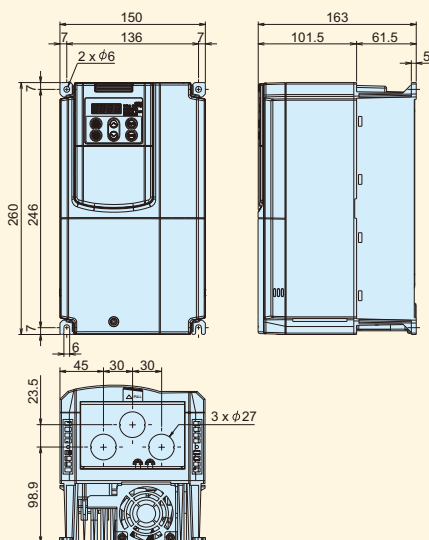

Power supply voltage	Type
Three-phase 200V	FRN0.75F1S-2A
	FRN1.5F1S-2A
	FRN2.2F1S-2A
	FRN3.7F1S-2A
	FRN5.5F1S-2A
Three-phase 400V	FRN0.75F1S-4A
	FRN1.5F1S-4A
	FRN2.2F1S-4A
	FRN3.7F1S-4A
	FRN5.5F1S-4A

Main body of standard inverter (7.5 to 30kW)

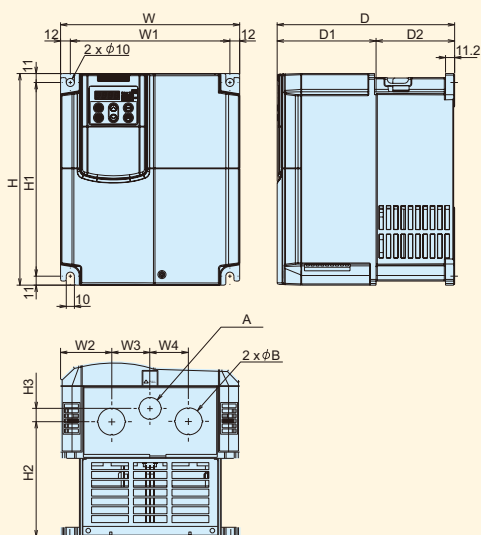

Power supply voltage	Type	Dimensions (mm)													
		W	W1	W2	W3	W4	H	H1	H2	H3	D	D1	D2	φA	φB
Three-phase 200V	FRN7.5F1S-2A	220	196	63.5	46.5	46.5	260	238	141.7	16	215	118.5	96.5	27	34
	FRN11F1S-2A								136.7	21					
	FRN15F1S-2A								85	130					
	FRN18.5F1S-2A	250	226	67	58	58	400	378	166.2	2	—	—	—	—	
	FRN30F1S-2A	—	—	—	—	—	—	—	—	—	—	—	—	—	—
Three-phase 400V	FRN7.5F1S-4A	220	196	63.5	46.5	46.5	260	238	141.7	16	215	118.5	96.5	27	34
	FRN11F1S-4A								136.7	21					
	FRN15F1S-4A								85	130					
	FRN18.5F1S-4A	250	226	67	58	58	400	378	166.2	2	—	—	—	—	
	FRN30F1S-4A	—	—	—	—	—	—	—	—	—	—	—	—	—	—

Main body of standard inverter (37 to 560kW)

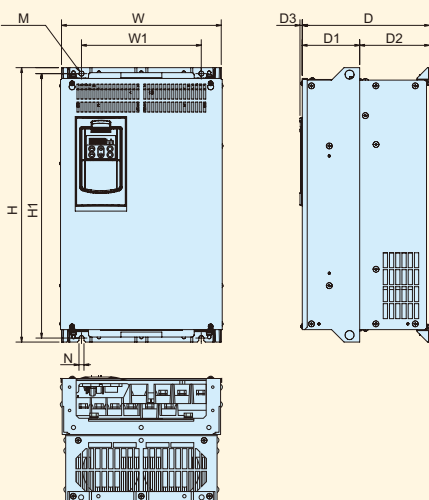

Power supply voltage	Type	Dimensions (mm)											
		W	W1	H	H1	D	D1	D2	D3	M	N		
Three-phase 200V	FRN37F1S-2A	320	240	550	530	255	115	140	155	4.5	2xφ10	10	
	FRN45F1S-2A	355	275	615	595	270							
	FRN55F1S-2A			740	720								
	FRN75F1S-2A	530	430	750	720	380	240						
	FRN90F1S-2A	680	580	880	850	395	255	140	6	2xφ15	3xφ15	15	
	FRN110F1S-2A	—	—	—	—	—	—	—	—	—	—	—	
Three-phase 400V	FRN37F1S-4A	320	240	550	530	255	115	140	155	4.5	2xφ10	10	
	FRN45F1S-4A	355	275	615	595	270							
	FRN55F1S-4A			740	720								
	FRN75F1S-4A	530	430	740	710	315	135	180	6	2xφ10	10		
	FRN90F1S-4A	680	580	880	850	360	180	180	—	—	—	—	
	FRN110F1S-4A	—	—	—	—	—	—	—	—	—	—	—	
	FRN132F1S-4A	530	430	1000	970	360	180	180	—	—	—	—	
	FRN160F1S-4A			1000	970	380	200	—	—	—	—	—	—
	FRN200F1S-4A			1000	970	380	200	—	—	—	—	—	—
	FRN220F1S-4A	680	580	1400	1370	440	260	180	6	3xφ15	15	—	
	FRN280F1S-4A												
	FRN315F1S-4A												
	FRN355F1S-4A												
	FRN400F1S-4A	880	780	1400	1370	440	260	180	6	4xφ15	15	—	
FRN450F1S-4A													
FRN500F1S-4A													
FRN560F1S-4A	—	—	—	—	—	—	—	—	—	—	—		

Inverter main body with built-in DCR (5.5kW or smaller)

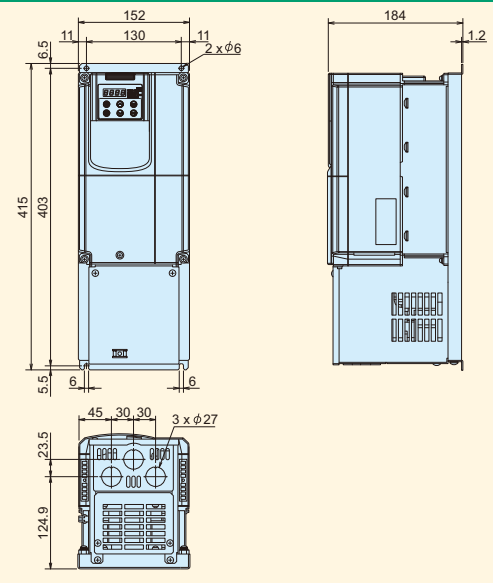

Power supply voltage	Type
Three-phase 200V	FRN0.75F1H-2A
	FRN1.5F1H-2A
	FRN2.2F1H-2A
	FRN3.7F1H-2A
	FRN5.5F1H-2A
Three-phase 400V	FRN0.75F1H-4A
	FRN1.5F1H-4A
	FRN2.2F1H-4A
	FRN3.7F1H-4A
	FRN5.5F1H-4A

Inverter main body with built-in DCR (7.5 to 30kW)

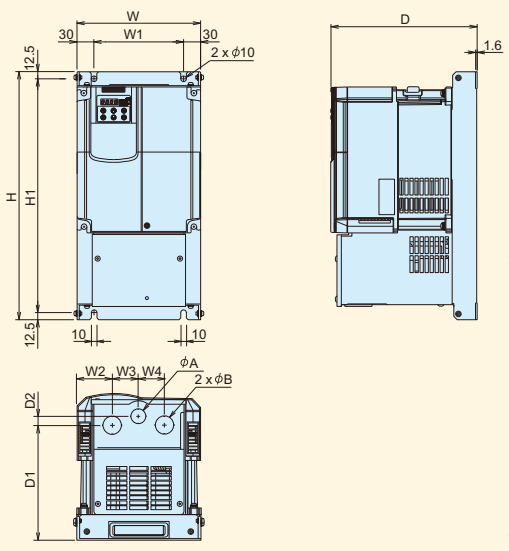

Power supply voltage	Type	Dimensions (mm)											
		W	W1	W2	W3	W4	H	H1	D	D1	D2	φA	φB
Three-phase 200V	FRN7.5F1H-2A	220	160	63.5	46.5	46.5	440	415	260	205.5	16	27	34
	FRN11F1H-2A												
	FRN15F1H-2A												
	FRN18.5F1H-2A												
	FRN22F1H-2A												
Three-phase 400V	FRN30F1H-2A	250	190	66	59	59	600	575	260	202	7	34	48
	FRN7.5F1H-4A												
	FRN11F1H-4A												
	FRN15F1H-4A												
	FRN18.5F1H-4A												
Three-phase 400V	FRN22F1H-4A	220	160	63.5	46.5	46.5	440	415	260	205.5	16	27	34
	FRN30F1H-4A												
	FRN7.5F1H-4A												
	FRN11F1H-4A												
	FRN15F1H-4A												
Three-phase 400V	FRN18.5F1H-4A	250	190	66	59	59	600	575	260	202	7	34	48
	FRN22F1H-4A												
	FRN30F1H-4A												
	FRN7.5F1H-4A												
	FRN11F1H-4A												

Inverter main body with built-in DCR (37 to 75kW)

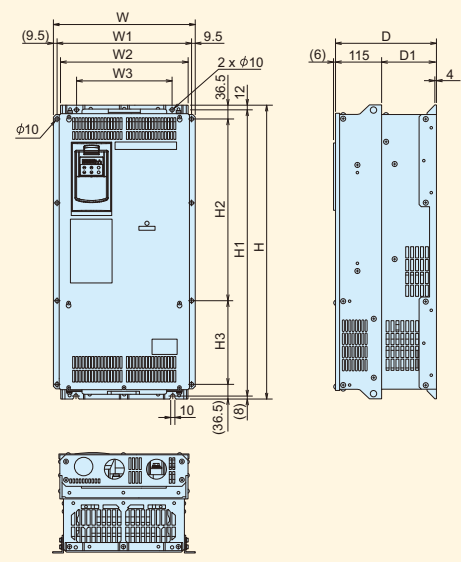

Power supply voltage	Type	Dimensions (mm)										
		W	W1	W2	W3	H	H1	H2	H3	D	D1	
Three-phase 200V	FRN37F1H-2A	355	336	320	240	770	750	477	220	255	140	
	FRN45F1H-2A											
	FRN55F1H-2A											
	FRN75F1H-2A											
Three-phase 400V	FRN37F1H-4A	355	336	320	240	770	750	477	220	255	140	
	FRN45F1H-4A											
	FRN55F1H-4A											
	FRN75F1H-4A											



External Dimensions

Inverter main body with built-in EMC filter (5.5kW or smaller)

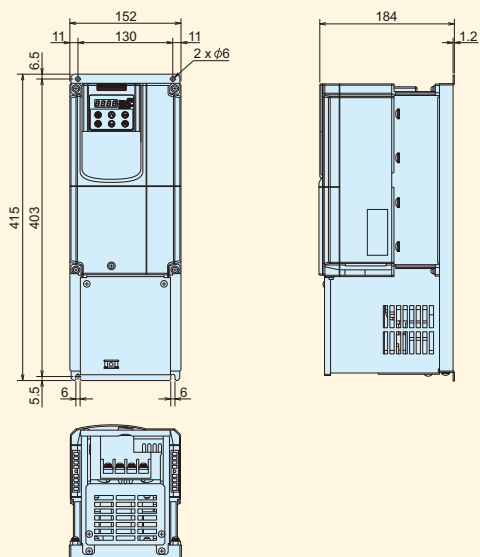

Power supply voltage	Type
Three-phase 200V	FRN0.75F1E-2A
	FRN1.5F1E-2A
	FRN2.2F1E-2A
	FRN3.7F1E-2A
	FRN5.5F1E-2A
Three-phase 400V	FRN0.75F1E-4A
	FRN1.5F1E-4A
	FRN2.2F1E-4A
	FRN3.7F1E-4A
	FRN5.5F1E-4A

Inverter main body with built-in EMC filter (7.5 to 15kW)

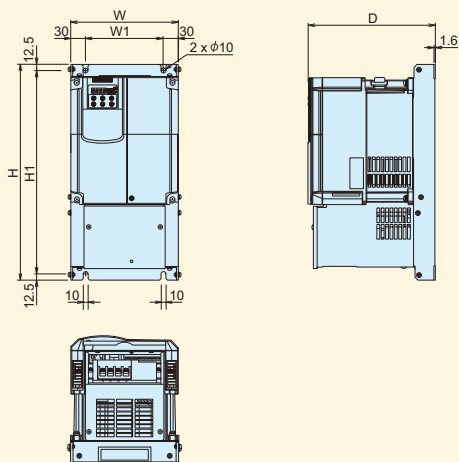

Power supply voltage	Type	Dimensions (mm)				
		W	W1	H	H1	D
Three-phase 200V	FRN7.5F1E-2A	220	160	440	415	260
	FRN11F1E-2A					
	FRN15F1E-2A					
Three-phase 400V	FRN7.5F1E-4A	220	160	440	415	260
	FRN11F1E-4A					
	FRN15F1E-4A					

Keypad (standard accessory)

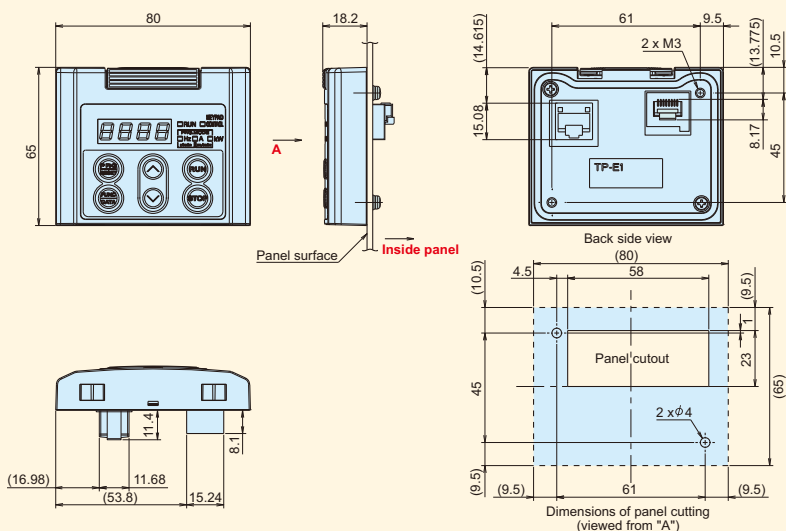

Inverter main body of waterproof type (IP54) (5.5kW or smaller)

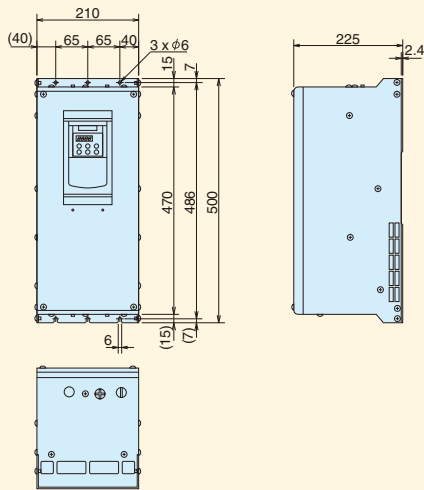

Power supply voltage	Type
Three-phase 200V	FRN0.75F1L-2A
	FRN1.5F1L-2A
	FRN2.2F1L-2A
	FRN3.7F1L-2A
	FRN5.5F1L-2A
Three-phase 400V	FRN0.75F1L-4A
	FRN1.5F1L-4A
	FRN2.2F1L-4A
	FRN3.7F1L-4A
	FRN5.5F1L-4A

Inverter main body of waterproof type (IP54) (7.5kW to 90kW)

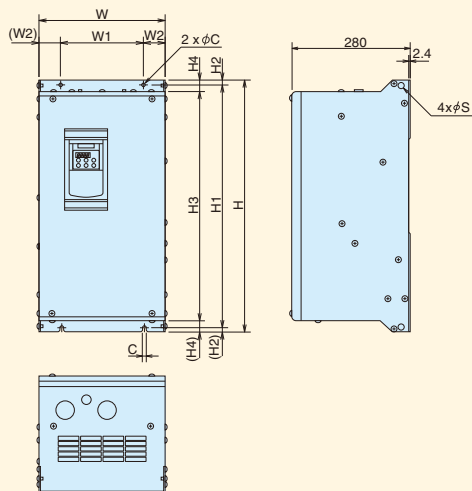

Power supply voltage	Type	Dimensions (mm)											
		W	W1	W2	H	H1	H2	H3	H4	D	C	S	
Three-phase 200V	FRN7.5F1L-2A	300	200	50	600	580	10	550	25	280	10	15	
	FRN11F1L-2A												
	FRN15F1L-2A												
	FRN18.5F1D-2A	350	290	30	800	780	15	750	35	320	15	18	
													FRN22F1D-2A
													FRN30F1D-2A
	FRN37F1D-2A	400	360	20	1100	1073	15	1030	35	360	15	18	
FRN45F1D-2A													
Three-phase 400V	FRN7.5F1L-4A	300	200	50	600	580	10	550	25	280	10	15	
	FRN11F1L-4A												
	FRN15F1L-4A												
	FRN18.5F1L-4A	350	290	30	800	780	15	750	35	320	15	18	
													FRN22F1L-4A
													FRN30F1L-4A
	FRN37F1L-4A	400	360	20	1100	1073	15	1030	35	350	15	18	
													FRN45F1L-4A
	FRN55F1L-4A	450	400	25	1170	1140	15	1100	35	360	15	18	
													FRN75F1L-4A
	FRN90F1L-4A	450			1280	1250		1210					

Wiring Diagram

The following diagram is for reference only. For detailed wiring diagrams, refer to the Instruction Manual.

Keypad operation

Run/Stop operation and frequency setting on the keypad

[Wiring procedure]

- Wire the inverter main power circuit.

[Operation method]

- Run/Stop : Press **RUN** or **STOP** key on the keypad.
- Setting frequency : Set the frequency with **▲** or **▼** key.

Note1: When connecting a DC REACTOR (DCR option), remove the jumper bar from across the terminals [P1] and [P (+)]. The DCR is a standard accessory for 75kW or larger capacity inverters. It must be connected when provided.

Note2: Install a recommended molded-case circuit-breaker (MCCB) or an earth-leakage circuit-breaker (ELCB) (with an overcurrent protection function) in the primary circuit of the inverter to protect wiring. At this time, ensure that the circuit breaker capacity is equivalent to or lower than the recommended capacity.

Note3: Install a magnetic contactor (MC) for each inverter to separate the inverter from the power supply, apart from the MCCB or ELCB, when necessary. Connect a surge suppressor in parallel when installing a coil such as the MC or solenoid near the inverter.

Note4: Connect the control circuit with the main circuit power supply to bring the inverter in a waiting state. If this terminal is not connected, the inverter can still be operated with the application of main power.

Operation by external signal inputs

Run/Stop operation and frequency setting through external signals

[Wiring procedure]

- Wire both the inverter main power circuit and control circuit.
- Set **f** (external signal) at function code **FB2**. Next, set **i** (voltage input (terminal 12) (0 to +10VDC)), **z** (current input (terminal C1) (+4 to 20mADC)), or other value at function code **FB i**.

[Operation method]

- Run/Stop : Operate the inverter across terminals FDW and CM short-circuited, and stop with open terminals.
- Frequency setting : Voltage input (0 to +10VDC), current input (+4 to 20mADC)

Note1: When connecting a DC REACTOR (DCR option), remove the jumper bar from across the terminals [P1] and [P (+)]. The DCR is a standard accessory for 75kW or larger capacity inverters. It must be connected when provided.

Note2: Install a recommended molded-case circuit-breaker (MCCB) or an earth-leakage circuit-breaker (ELCB) (with an overcurrent protection function) in the primary circuit of the inverter to protect wiring. At this time, ensure that the circuit breaker capacity is equivalent to or lower than the recommended capacity.

Note3: Install a magnetic contactor (MC) for each inverter to separate the inverter from the power supply, apart from the MCCB or ELCB, when necessary. Connect a surge suppressor in parallel when installing a coil such as the MC or solenoid near the inverter.

Note4: Connect the control circuit with the main circuit power supply to bring the inverter in a waiting state. If this terminal is not connected, the inverter can still be operated with the application of main power.

Note5: Frequency can be set by connecting a frequency setting device (external potentiometer) between the terminals 11, 12 and 13 instead of inputting a voltage signal (0 to +10V DC, 0 to +5V DC or +1 to +5V DC) between the terminals 12 and 11.

Note6: For the control signal wires, use shielded or twisted wires. Ground shielded wires. To prevent malfunction due to noise, keep the control circuit wiring away from the main circuit wiring as far as possible (recommended: 10cm or more). Never install them in the same wire duct. When crossing the control circuit wiring with the main circuit wiring, set them at right angles.

Terminal Functions

Terminal Functions

Division	Symbol	Terminal name	Functions	Remarks	Related function code																																												
Main circuit	L1/R,L2/S,L3/T	Power input	Connect a three-phase power supply.																																														
	R0,T0	Auxiliary control power input	Connect a single-phase power supply.																																														
	R1,T1	Auxiliary fan power input	There is no need to connect during normal operation. Use these terminals for applications combined with a high power-factor PWM converter with power regeneration function or the like.																																														
	U,V,W	Inverter output	Connect a three-phase motor.																																														
	P(+),P1	For DC REACTOR	Connect the DC reactor (DCR).																																														
	P(+),N(-)	For DC bus connection	Used for DC bus connection.																																														
Frequency setting	⊕G	Grounding	Terminal for inverter grounding	Two terminals are provided.																																													
	13	Potentiometer power supply	Used for frequency setting device power supply (variable resistance: 1 to 5kΩ) (10V DC 10mA DC max.)																																														
	12	Voltage input	Used as a frequency setting voltage input. 0 to +10V DC/0 to 100% (0 to +5V DC/0 to 100%) +10 to 0V DC/0 to 100%	Input impedance: 22kΩ Maximum input: +15V DC	F18 C32 to C34 E61																																												
		(Inverse operation)																																															
		(PID control)	Used for setting signal (PID process command value) or feedback signal.																																														
		(Frequency aux. setting)	Used as additional auxiliary setting to various frequency settings.																																														
		(Analog input monitor)	The peripheral analog signal can be displayed on the keypad. (Displaying coefficient: valid)																																														
	C1	Current input	Used as a frequency setting current input. 4 to 20mA DC/0 to 100% 20 to 4mA DC/0 to 100%	Input impedance: 250Ω Maximum input: 30mA DC	F18 C37 to C39 E62																																												
		(Inverse operation)																																															
		(PID control)	Used for setting signal (PID process command value) or feedback signal.																																														
		(Frequency aux. setting)	Used as additional auxiliary setting to various frequency settings.																																														
	(Analog input monitor)	The peripheral analog signal can be displayed on the keypad. (Displaying coefficient: valid)																																															
V2	Analog setting voltage input	Used as a frequency setting voltage input. 0 to +10V DC/0 to 100% (0 to +5V DC/0 to 100%) +10 to 0V DC/0 to 100%	Input impedance: 22kΩ Maximum input: +15V DC	F18 C42 to C44 E63																																													
	(Inverse operation)																																																
	(PID control)	Used for setting signal (PID process command value) or feedback signal.																																															
	(For PTC thermistor)	Connects PTC thermistor for motor protection.																																															
	(Frequency aux. setting)	Used as additional auxiliary setting to various frequency settings.																																															
	(Analog input monitor)	The peripheral analog signal can be displayed on the keypad. (Displaying coefficient: valid)																																															
11	Analog common	Common terminal for frequency setting signals (12, 13, C1, V2, FMA)	Isolated from terminals CM and CMY. Two terminals are provided.																																														
Digital input	X1	Digital input 1	The following functions can be set at terminals X1 to X5, FWD and REV for signal input. <Common function> • Sink and source are changeable using the built-in sliding switch. • ON timing can be changed between short-circuit of terminals X1 and CM and open circuits of them. The same setting is possible between CM and any of the terminals among X2, X3, X4, X5, FWD, and REV.	ON state	E01																																												
	X2	Digital input 2		Source current: 2.5 to 5mA	E02																																												
	X3	Digital input 3		Voltage level: 2V	E03																																												
	X4	Digital input 4		OFF state	E04																																												
	X5	Digital input 5		Allowable leakage current: Smaller than 0.5mA	E05																																												
	FWD	Forward operation command	The motor runs in the forward direction upon ON across (FWD) and CM. The motor decelerates and stops upon OFF.	This function can be set only for the terminals FWD and REV.	E98																																												
	REV	Reverse operation command			The motor runs in the reverse direction upon ON across (REV) and CM. The motor decelerates and stops upon OFF.	E99																																											
		(FWD)	8-step operation can be conducted with ON/OFF signals at (SS1) to (SS4).	<table border="1"> <thead> <tr> <th>Digital input</th> <th colspan="7">Multistep frequency</th> </tr> <tr> <th></th> <th>0</th> <th>1</th> <th>2</th> <th>3</th> <th>4</th> <th>5</th> <th>6</th> <th>7</th> </tr> </thead> <tbody> <tr> <td>(SS1)</td> <td>-</td> <td>ON</td> <td>-</td> <td>ON</td> <td>-</td> <td>ON</td> <td>-</td> <td>ON</td> </tr> <tr> <td>(SS2)</td> <td>-</td> <td>-</td> <td>ON</td> <td>ON</td> <td>-</td> <td>-</td> <td>ON</td> <td>ON</td> </tr> <tr> <td>(SS4)</td> <td>-</td> <td>-</td> <td>-</td> <td>-</td> <td>ON</td> <td>ON</td> <td>ON</td> <td>ON</td> </tr> </tbody> </table>	Digital input	Multistep frequency								0	1	2	3	4	5	6	7	(SS1)	-	ON	-	ON	-	ON	-	ON	(SS2)	-	-	ON	ON	-	-	ON	ON	(SS4)	-	-	-	-	ON	ON	ON	ON	C05 to C11
	Digital input	Multistep frequency																																															
		0			1	2	3	4	5	6	7																																						
	(SS1)	-			ON	-	ON	-	ON	-	ON																																						
	(SS2)	-	-	ON	ON	-	-	ON	ON																																								
	(SS4)	-	-	-	-	ON	ON	ON	ON																																								
		(REV)																																															
		(SS1)																																															
		(SS2)																																															
		(SS4)																																															
		(HLD)	3-wire operation stop command	Used for 3-wire operation. ON across (HLD) and CM: The inverter self-holds FWD or REV signal. OFF across (HLD) and CM: The inverter releases self-holding.																																													
		(BX)	Coast-to-stop command	ON across (BX) and CM: The inverter output is shut off immediately and the motor coasts to a stop.	No alarm signal will be output.																																												
		(RST)	Alarm reset	ON across (RST) and CM: Faults are reset.	Alarm reset signal width: 0.1(s) or more																																												
		(THR)	Trip command (External fault)	OFF across (THR) and CM: The inverter output is shut off immediately and the motor coasts-to-stop.	Alarm signal BH2 will be output.																																												
		(Hz2/Hz1)	Freq. set 2/Freq. set 1	ON across (Hz2/Hz1) and CM: Freq. set 2 is effective.		F01, F30																																											
		(DCBRK)	DC braking command	ON across (DCBRK) and CM: Starts DC braking action.		F20 to F22																																											
		(SW50)	Line/inverter switch(50Hz)	OFF across (SW50) and CM: Starts at 50Hz.																																													
		(SW60)	Line/inverter switch(60Hz)	OFF across (SW60) and CM: Starts at 60Hz.																																													
		(UP)	UP command	The output frequency rises while the circuit across (UP) and CM is connected.		F01, C30																																											
		(DOWN)	DOWN command	The output frequency drops while the circuit across (DOWN) and CM is connected.		J02																																											
		(WE-KP)	Write enable for KEYPAD	The function code data can be changed from the keypad only when (WEE-KP) is ON.		F00																																											
		(Hz/PID)	PID cancel	PID control can be canceled when the circuit across (Hz/PID) and CM is connected. (Operation proceeds according to the selected frequency setting method such as the multi-step frequency, keypad and analog input.)		J01 to J06 J10 to J19																																											
		(IVS)	Inverse mode changeover	The frequency setting or PID control output signal (frequency setting) action mode switches between normal and inverse actions when the circuit across (IVS) and CM is connected.		C50, J01																																											
	(IL)	Interlock	Connect an auxiliary contact of a switch installed between the inverter and motor. This signal is input upon momentary power failure to detect momentary power failure, and the inverter restarts upon power recovery.		F14																																												
	(LE)	Link enable (RS485, Bus)	Operation proceeds according to commands sent via RS485 communication or field bus (option) when the circuit across (LE) and CM is connected.		H30, y98																																												
	(U-DI)	Universal DI	An arbitrary digital input signal is transmitted to the host controller.																																														
	(STM)	Starting characteristic selection	ON across (STM) and CM: Starting at the pick-up frequency becomes valid.		H17, H09																																												
	(STOP)	Forcible stop	OFF across (STOP) and CM: The inverter is forcibly stopped in the special deceleration time.		H56																																												
	(PID-RST)	PID differentiation / integration reset	ON across (PID-RST) and CM: Resets differentiation and integration values of PID.		J01 to J06																																												
	(PID-HLD)	PID integral hold	ON across (PID-HLD) and CM: Holds integration values of PID.		J10 to J19																																												
	(LOC)	Local (keypad) command selection	ON across (LOC) and CM: The operation commands and frequency settings given at the keypad become valid.																																														
	(RE)	Operation permission	After an operation command is input, operation starts upon activation of (RE).																																														
	(DWP)	Dew prevention	ON across (DWP) and CM: A current flows through the motor to avoid motor temperature drop during inverter stoppage so that condensation will not occur.		J21 F21, F22 J22																																												
	(ISW50)	Line/inverter switching sequence(50Hz)	OFF across (ISW50) and CM: Line operation starts according to the switching sequence built in the inverter. (For 50Hz commercial line)																																														
	(ISW60)	Line/inverter switching sequence(60Hz)	OFF across (ISW60) and CM: Line operation starts according to the switching sequence built in the inverter. (For 60Hz commercial line)		J22																																												
	(FR2/FR1)	Operation command 2/1	ON across (FR2/FR1) and CM: The operation command switches to (FWD2) (REV2) side.		F02																																												
	(FWD2)	Forward rotation/stop command 2	Forward operation upon ON across (FWD) and CM. Deceleration and stop upon OFF. (Second operation command)																																														
	(REV2)	Reverse operation/stop command 2	Reverse operation upon ON across (REV) and CM. Deceleration and stop upon OFF. (Second operation command)																																														
PLC	PLC terminal	Connect to PLC output signal power supply. Common for 24V power.		+24V 50mA max.																																													
CM	Common	Common terminal for digital input signal		Isolated from terminals 11 and CMY .Two terminals are provided.																																													

Wiring Diagram

Terminal Functions



Terminal Functions

Terminal Functions

Division	Symbol	Terminal name	Functions	Remarks	Related function code
Analog output	FMA	Analog monitor	The output style can be selected between DC voltage (0 to 10V) and DC current (4 to 20mA). One of the following items can be output in the selected output style. • Output frequency. • Output current. • Output voltage. • Output torque. • Load factor. • Input power. • PID feedback value. • DC link circuit voltage. • Universal AO. • Motor output. • Analog output test. • PID command. • PID output	In the case of voltage output, up to two analog voltmeters (0 to 10Vdc, input impedance: 10kΩ) can be connected. In the case of current output, analog ammeters (up to 500Ω) can be connected. Gain adjustment range: 0 to 200%	F29 to F31
	FMP	Pulse monitor	One of the following items can be output in a pulse frequency. • Output frequency. • Output current. • Output voltage. • Output torque. • Load factor. • Power consumption. • PID feedback value. • DC link circuit voltage. • Universal AO. • Motor output. • Analog output test. • PID command. • PID output	Up to two analog voltmeters (0 to 10Vdc, input impedance: 10kΩ) can be connected. (Driven at average voltage) Gain adjustment range: 0 to 200%	F33 to F35
Transistor output	(PLC)	Transistor output power	• Power supply for a transistor output load.(24Vdc 50mA Max.)(Note: Same terminal as digital input PLC terminal)	Short circuit across terminals CM and CMY to use.	
	Y1	Transistor output 1	The following functions can be set at terminals Y1 to Y3 for signal output.	Max. voltage: 27Vdc, max. current: 50mA, leak current: 0.1mA max., ON voltage: within 2V (at 50mA)	E20
	Y2	Transistor output 2	• The setting of "short circuit upon active signal output" or "open upon active signal output" is possible.		E21
	Y3	Transistor output 3	• Sink/source support (switching unnecessary)		E22
	(RUN)	Inverter running (speed exists)	An active signal is issued when the inverter runs at higher than the starting frequency.		
	(RUN2)	Inverter output on	A signal is issued when the inverter runs at smaller than the starting frequency or when DC braking is in action.		
	(FAR)	Speed/freq. arrival	An active signal is issued when the output frequency reaches the set frequency.	Detection width (fixed): 2.5 (Hz)	
	(FDT)	Speed/freq. detection	An active signal is issued at output frequencies above a preset detection level. The signal is deactivated if the output frequency falls below the detection level.	Hysteresis width (fixed): 1.0 (Hz)	E31
	(LV)	Undervoltage detection	The signal is output when the inverter stops because of undervoltage.		
	(IOL)	Inverter output limit (limit on current)	The signal is output when the inverter is limiting the current.		F43, F44
	(IPF)	Auto-restarting	The signal is output during auto restart operation (after momentary power failure and until completion of restart).		F14
	(OL)	Overload early warning (motor)	The signal is output when the electronic thermal relay value is higher than the preset alarm level.		F10 to F12
	(RDY)	Operation ready output	A signal is issued if preparation for inverter operation is completed.		
	(SW88)	Line-to-inverter switching	The magnetic contactor on the line side of line-to-inverter switching is controlled.		
	(SW52-2)	Line-to-inverter switching	The magnetic contactor on the inverter output side (secondary side) of line-to-inverter switching is controlled.		
	(SW52-1)	Line-to-inverter switching	The magnetic contactor on the inverter input side (primary side) of line-to-inverter switching is controlled.		
	(AX)	AX terminal function	The electromagnetic contactor on the inverter input side (primary side) is controlled.		
	(FAN)	Cooling fan ON/OFF control	The ON/OFF signal of the cooling fan is issued.		H06
	(TRY)	Retry in action	The signal is output during an active retry.		H04, H05
	(U-DO)	Universal DO	The signal transmitted from the host controller is issued.		
	(OH)	Heat sink overheat early warning	An early warning signal is issued before the heat sink trips due to an overheat.		
	(LIFE)	Lifetime alarm	Outputs alarm signal according to the preset lifetime level.		H42, H43, H98
	(REF OFF)	Command loss detection	A loss of the frequency command is detected.		E65
	(OLP)	Overload preventive control	The signal is output when the overload control is activated.		H70
	(ID)	Current detection	The signal is output when a current larger than the set value has been detected for the timer-set time.		E34, E35
	(PID-ALM)	PID alarm output	An absolute value alarm or deviation alarm under PID control is issued as a signal.		J11 to J13
	(PID-CTL)	Under PID control	The valid state of PID control is issued as a signal.		
	(PID-STP)	PID stop upon small water flow	A signal is issued if operation is stopped due to a small water flow under PID control. (The inverter is stopped even if the operation command is issued.)		J15 to J17
(U-TL)	Low torque detection	A signal is issued if the torque falls below the preset low torque detection level for a set time.		E80, E81	
(RMT)	In remote mode	A signal is issued in the remote mode.			
(AX2)	Operation command input	A signal is issued if there is an operation command input and operation ready is completed.			
(ALM)	Alarm relay output (for any fault)	An alarm relay output (for any fault) signal is issued as a transistor output signal.			
Contact output	CMY	Transistor output common	Common terminal for transistor output	The terminal is isolated from terminals 11 and CM.	
	Y5A, Y5C	General-purpose relay output	• Multi-purpose relay output; signals similar to above-mentioned signals Y1 to Y3 can be selected. • An alarm output is issued upon either excitation or no excitation according to selection.	Contact capacity: 250 V AC, 0.3A, cosφ=0.3 +48 V DC, 0.5A	E24
Communication	30A, 30B, 30C	Alarm relay output (for any fault)	• A no-voltage contact signal (1c) is issued when the inverter is stopped due to an alarm. • Multi-purpose relay output; signals similar to above-mentioned signals Y1 to Y3 can be selected. • An alarm output is issued upon either excitation or no excitation according to selection.		E27
	—	RJ45 connector for connection with the keypad	One of the following protocols can be selected. • Modbus RTU • Protocol exclusively for keypad (default selection) • Fuji's special inverter protocol • SX protocol for PC loader	Power (+5V) is supplied to the keypad.	H30 y01 to y20 y98, y99

Terminal Arrangement

Main circuit terminals

Power supply voltage	Applicable motor rating (kW)	Inverter type	Reference
Three-phase 200V	0.75	FRN0.75F1□-2A	Fig. A
	1.5	FRN1.5F1□-2A	
	2.2	FRN2.2F1□-2A	
	3.7	FRN3.7F1□-2A	Fig. B
	5.5	FRN5.5F1□-2A	
	7.5	FRN7.5F1□-2A	
	11	FRN11F1□-2A	Fig. C
	15	FRN15F1□-2A	
	18.5	FRN18.5F1□-2A	
	22	FRN22F1□-2A	Fig. D
	30	FRN30F1□-2A	
	37	FRN37F1□-2A	
	45	FRN45F1□-2A	Fig. E
55	FRN55F1□-2A		
75	FRN75F1□-2A		
Three-phase 400V	0.75	FRN0.75F1□-4A	Fig. A
	1.5	FRN1.5F1□-4A	
	2.2	FRN2.2F1□-4A	
	3.7	FRN3.7F1□-4A	Fig. B
	5.5	FRN5.5F1□-4A	
	7.5	FRN7.5F1□-4A	
	11	FRN11F1□-4A	Fig. C
	15	FRN15F1□-4A	
	18.5	FRN18.5F1□-4A	
	22	FRN22F1□-4A	Fig. D
	30	FRN30F1□-4A	
	37	FRN37F1□-4A	
	45	FRN45F1□-4A	Fig. E
	55	FRN55F1□-4A	
	75	FRN75F1□-4A	
	90	FRN90F1□-4A	Fig. F
	110	FRN110F1□-4A	
	132	FRN132F1□-4A	
160	FRN160F1□-4A	Fig. G	
200	FRN200F1□-4A		
220	FRN220F1□-4A		
280	FRN280F1□-4A	Fig. H	
315	FRN315F1□-4A		
355	FRN355F1□-4A		
400	FRN400F1□-4A	Fig. I	
450	FRN450F1□-4A		
500	FRN500F1□-4A		
560	FRN560F1□-4A	Fig. J	

Note: Substitute "□" in the inverter model number with an alphabetic letter.

- S (Standard type)
- E (EMC filter built-in type)
- H (DC REACTOR built-in type)
- L or D (Waterproof type)

Fig. A

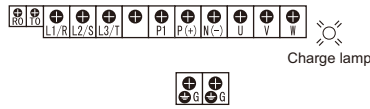

Fig. B



Fig. C

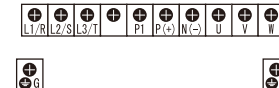

Fig. D



Fig. E

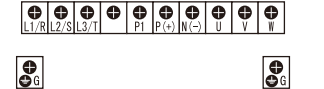

Fig. F

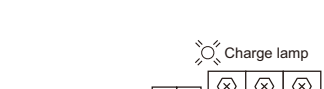

Fig. G

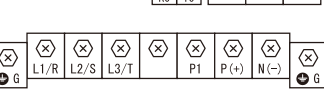

Fig. H

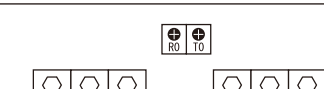

Fig. I

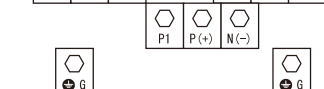

Fig. J

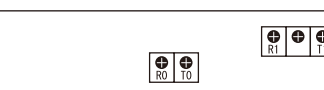

Fig. K

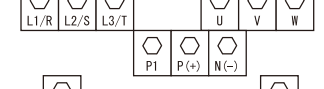

Fig. L

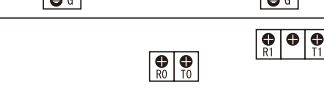

Fig. M



Fig. N



Fig. H

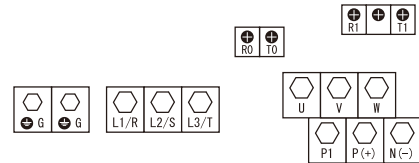

Fig. I

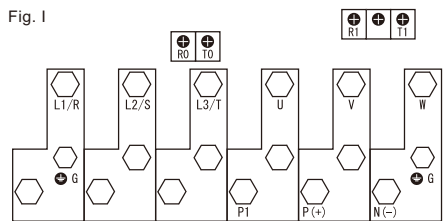

Fig. J

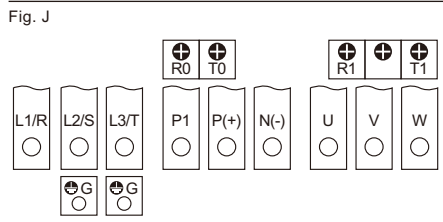

Fig. K

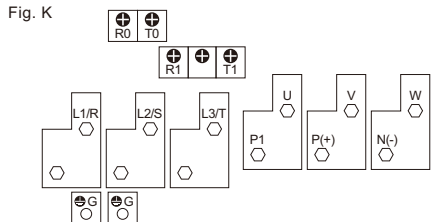

Fig. L

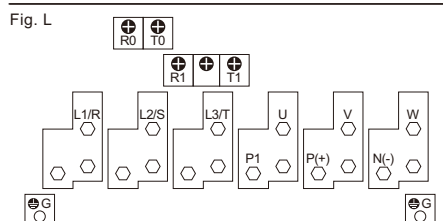

Fig. M

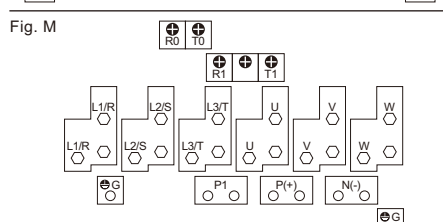
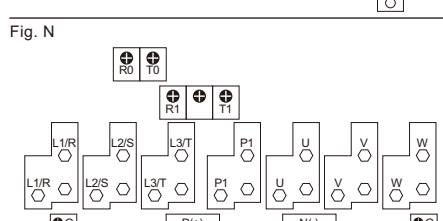
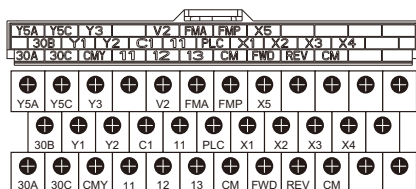

Fig. N



Control circuit terminals (common to all models)



Terminal sizes: M3



Keypad Operations

Keypad switches and functions

LED monitor

When the motor is running or stopped:

The monitor displays parameters such as output frequency, set frequency, motor speed, load shaft speed, output voltage, output current, and input power.

Alarm mode:

The monitor shows the alarm description with a fault code.

Program/Reset key

Used to change the mode.

Programming mode:

Used to shift the digit (cursor movement) to set data.

Alarm mode:

Resets a trip.

Function/Data select key

Used to change the LED monitor and to store the function code and data.

Up/Down keys

During operation :Used to increase or decrease the frequency or motor speed.

In data setting :Used to indicate the function code number or to change data set value.

Operation mode display

During keypad operation:

When function code **F 02** is **0**, **2** or **3** (keypad operation), the green KEYPAD CONTROL LED lights up.

During operation:

The green RUN LED lights up.

Unit display

The unit of the data displayed at the LED monitor is indicated. Use the **FUNC DATA** key to switch the displayed data.

Run key

Used to start the operation.

While the motor is stopped:

This key is invalid if the function code **F 02** is set to **1** (operation by external signals).

Stop key

Used to stop the operation.

During operation:

This key is invalid if the function code **F 02** is set to **1** (operation by external signals).

The inverter stops when the function code **H 96** is set to **1** or **3**.



Monitor display and key operation

Monitor, keys	Operation mode	Programming mode		Running mode		Alarm mode
		STOP	RUN	STOP	RUN	
Monitor PRG.MODE <input type="checkbox"/> Hz <input type="checkbox"/> A <input type="checkbox"/> kW <input type="checkbox"/> r/min <input type="checkbox"/> m/min	Function	Displays the function code or data.		Displays the output frequency, set frequency, loaded motor speed, required power, output current, and output voltage.		Displays the alarm description and alarm history.
	Display	ON		Blinking	ON	Blinking/ON
	Function	The program mode is indicated.		Displays the unit of frequency, output current, required power, speed, and line speed.		None
	Display	PRG.MODE <input type="checkbox"/> Hz <input type="checkbox"/> A <input type="checkbox"/> kW ON <input type="checkbox"/> r/min <input type="checkbox"/> m/min		Frequency indication <input type="checkbox"/> Hz <input type="checkbox"/> A <input type="checkbox"/> kW ON <input type="checkbox"/> r/min <input type="checkbox"/> m/min	Speed indication <input type="checkbox"/> Hz <input type="checkbox"/> A <input type="checkbox"/> kW ON <input type="checkbox"/> r/min <input type="checkbox"/> m/min	Capacity or current indication <input type="checkbox"/> Hz <input type="checkbox"/> A <input type="checkbox"/> kW <input type="checkbox"/> Blink or lit <input type="checkbox"/> r/min <input type="checkbox"/> m/min
Keys <input type="checkbox"/> KEYPAD CONTROL <input type="checkbox"/> RUN 	Function	Operation selection (keypad operation/terminal operation) is displayed.				
	Display	Lit in keypad operation mode				
	Function	Absence of operation command is displayed.	Presence of operation command is displayed.	Absence of operation command is displayed.	Presence of operation command is displayed.	Stoppage due to trip is displayed.
	Display	<input type="checkbox"/> RUN unlit	<input checked="" type="checkbox"/> RUN lit	<input type="checkbox"/> RUN unlit	<input checked="" type="checkbox"/> RUN lit	If an alarm occurs during operation, unlit during keypad operation or lit during terminal block operation.
	Function	Switches to running mode Digit shift (cursor movement) in data setting		Switches to programming mode		Releases the trip and switches to stop mode or running mode.
Function	Determines the function code, stores and updates data.		Switches the LED monitor display.		Displays the operation information.	
Function	Increases/decreases the function code and data.		Increases/decreases the frequency, motor speed and other settings.		Displays the alarm history.	
Function	Invalid		Starts running (switches to running mode (RUN)).		Invalid	
Function	Invalid		Deceleration stop (Switches to programming mode STOP).		Deceleration stop (Switches to running mode STOP).	Invalid

This keypad supports a full menu mode which allows you to set or display the following information: Indication and setting change of changed function code, drive monitor, I/O check, maintenance information, and alarm information. For concrete operation methods, refer to the FRENIC-Eco Instruction Manual or User's Manual.

Function Settings

Function Settings

F codes: Fundamental Functions

Code	Name	Data setting range	Increment	Unit	Data copying	Default setting
F00	Data Protection	0 : Disable data protection 1 : Enable data protection	—	—	Y	0
F01	Frequency Command 1	0 : Enable / keys on keypad 1 : Enable voltage input to terminal [12] (0 to 10 VDC) 2 : Enable current input to terminal [C1] (4 to 20 mA DC) 3 : Enable sum of voltage and current inputs to terminals [12] and [C1] 5 : Enable voltage input to terminal [V2] (0 to 10 VDC) 7 : Enable terminal command (UP) / (DOWN) control	—	—	Y	0
F02	Run Command	0 : / keypad operation (Rotational direction conforms to the digital input signal) 1 : External signal (digital input signal) 2 : / keypad operation (FWD) 3 : / keypad operation (REV)	—	—	Y	2
F03	Maximum Frequency	25.0 to 120.0	0.1	Hz	Y	Refer to table below.
F04	Base Frequency	25.0 to 120.0	0.1	Hz	Y	Refer to table below.
F05	Rated Voltage at Base Frequency	0 : Output a voltage in proportion to input voltage 80 to 240V: Output a voltage AVR-controlled (for 3-phase 200 V series) 160 to 500V: Output a voltage AVR-controlled (for 3-phase 400 V series)	1	V	Y2	Refer to table below.
F07	Acceleration Time 1	0.00 to 3600s Note: Entering 0.00 cancels the acceleration time, requiring external soft-start.	0.01	s	Y	20.0
F08	Deceleration Time 1	0.00 to 3600s Note: Entering 0.00 cancels the deceleration time, requiring external soft-stop.	0.01	s	Y	20.0
F09	Torque Boost	0.0 to 20.0 (Percentage of the rated voltage at base frequency (F05)) Note: This setting is effective when F37 = 0, 1, 3, or 4.	0.1	%	Y	Refer to table below.
F10	Electronic Thermal Overload Protection for Motor (Select motor characteristics)	1 : For general-purpose motors with built-in self-cooling fan 2 : For separately excited motor fan	—	—	Y	1
F11	(Overload detection level)	0.00: Disable 1 to 135% of the rated current (allowable continuous drive current) of the motor	0.01	A	Y1 Y2	100% of the motor rated current
F12	(Thermal time constant)	0.5 to 75.0	0.1	min	Y	5 (22 kW or below) 10 (30 kW or above)
F14	Restart Mode after Momentary Power Failure (Mode selection)	0 : Disable restart (Trip immediately without restart) 1 : Disable restart (Trip after a recovery from power failure without restart) 3 : Enable restart (Continue to run, for heavy inertia or general loads) 4 : Enable restart (Restart at the frequency at which the power failure occurred, for general loads) 5 : Enable restart (Restart at the starting frequency, for low-inertia load)	—	—	Y	1 (0) *2
F15	Frequency Limiter (High)	0.0 to 120.0	0.1	Hz	Y	70.0
F16	(Low)	0.0 to 120.0	0.1	Hz	Y	0.0
F18	Bias (Frequency command 1)	-100.00 to 100.00 *1	0.01	%	Y	0.00
F20	DC Braking (Braking start frequency)	0.0 to 60.0	0.1	Hz	Y	0.0
F21	(Braking level)	0 to 60 (Rated output current of the inverter interpreted as 100%)	1	%	Y	0
F22	(Braking time)	0.00 : Disable 0.01 to 30.00	0.01	s	Y	0.00
F23	Starting Frequency	0.1 to 60.0	0.1	Hz	Y	0.5
F25	Stop Frequency	0.1 to 60.0	0.1	Hz	Y	0.2
F26	Motor Sound (Carrier frequency)	0.75 to 15 (22 kW or below) *1 0.75 to 10 (30 to 75 kW) 0.75 to 6 (90 kW or above)	1	kHz	Y	2 (15/10/6) *2
F27	(Tone)	0 : Level 0 (Inactive) 1 : Level 1 2 : Level 2 3 : Level 3	—	—	Y	0
F29	Analog Output [FMA] (Mode selection)	0 : Output in voltage (0 to 10 VDC) 1 : Output in current (4 to 20 mA DC)	—	—	Y	0
F30	(Output adjustment)	0 to 200	1	%	Y	100
F31	(Function)	Select a function to be monitored from the followings. 0 : Output frequency 2 : Output current 3 : Output voltage 4 : Output torque 5 : Load factor 6 : Input power 7 : PID feedback value (PV) 9 : DC link bus voltage 10 : Universal AO 13 : Motor output 14 : Test analog output 15 : PID process command (SV) 16 : PID process output (MV)	—	—	Y	0
F33	Pulse Output [FMP] *3	25 to 6000 (Pulse rate at 100% output)	1	p/s	Y	1440
F34	(Pulse rate) (Duty)	0 : Output pulse rate (Fixed at 50% duty) 1 to 200 : Voltage output adjustment (Pulse rate is fixed at 2000 p/s. Adjust the maximum pulse duty.)	1	%	Y	0

Keypad Operations

Function Settings



Function Settings

Function Settings

F codes: Fundamental Functions

Code	Name	Data setting range	Increment	Unit	Data copying ²	Default setting
F35	Terminal FMP (Function)	Select a function with the code number from the followings. 0 : Output frequency 2 : Output current 3 : Output voltage 4 : Output torque 5 : Load factor 6 : Input power 7 : PID feedback value (PV) 9 : DC link bus voltage 10 : Universal AO 13 : Motor output 14 : Test analog output 15 : PID process command (SV) 16 : PID process output (MV)	—	—	Y	0
F37	Load Selection/ Auto Torque Boost/ Auto Energy Saving Operation	0 : Variable torque load (increasing in proportion to square of speed) 1 : Variable torque load (Higher startup torque required) 2 : Auto-torque boost 3 : Auto-energy saving operation(Variable torque load) 4 : Auto-energy saving operation(Variable torque load) (Higher startup torque required)Note:Apply this setting to a load with short acceleration time. 5 : Auto-energy saving operation(Auto torque boost)Note: Apply this setting to a load with long acceleration time.	—	—	Y	1
F43	Current Limiter (Mode selection)	0 : Disable (No current limiter works.) 1 : Enable at constant speed (Disabled during acceleration and deceleration) 2 : Enable during acceleration and at constant speed	—	—	Y	0
F44	(Level)	20 to 120 (The data is interpreted as the rated output current of the inverter for 100%).	1	%	Y	110

E codes: Extension Terminal Functions

Code	Name	Data setting range	Increment	Unit	Data copying ²	Default setting
E01	Terminal (Function) [X1]	Select a function with the code number from the followings.	—	—	Y	6
E02	Terminal [X2]	0 (1000) : Select multistep frequency (Step 0 or 1) (SS1)	—	—	Y	7
E03	Terminal [X3]	1 (1001) : Select multistep frequency (Step 0 or 3) (SS2)	—	—	Y	8
E04	Terminal [X4]	2 (1002) : Select multistep frequency (Step 0 or 7) (SS4)	—	—	Y	11
E05	Terminal [X5]	6 (1006) : Enable 3-wire operation (HLD) 7 (1007) : Coast to a stop (BX) 8 (1008) : Reset alarm (RST) 9 (1009) : Enable external alarm trip (THR) 11 (1011) : Switch frequency command 2/1 (Hz2/Hz1) 13 : Enable DC brake (DCBRK) 15 : Switch to commercial power (50 Hz) (SW50) 16 : Switch to commercial power (60 Hz) (SW60) 17 (1017) : UP (Increase output frequency) (UP) 18 (1018) : DOWN (Decrease output frequency) (DOWN) 19 (1019) : Enable write from keypad (Data changeable) (WE-KP) 20 (1020) : Cancel PID control (Hz/PID) 21 (1021) : Switch normal/inverse operation (IVS) 22 (1022) : Interlock (IL) 24 (1024) : Enable communications link via RS485 or field bus (option) (LE) 25 (1025) : Universal DI (U-DI) 26 (1026) : Select starting characteristics (STM) 30 (1030) : Force to stop (STOP) 33 (1033) : Reset PID integral and differential components (PID-RST) 34 (1034) : Hold PID integral component (PID-HLD) 35 (1035) : Select local (keypad) operation (LOC) 38 (1038) : Enable to run (RE) 39 : Protect motor from dew condensation (DWP) 40 : Enable integrated sequence to switch to commercial power (50 Hz) (ISW50) 41 : Enable integrated sequence to switch to commercial power (60 Hz) (ISW60) 50 (1050) : Clear periodic switching time (MCLR) 51 (1051) : Enable pump drive (motor 1) (MEN1) 52 (1052) : Enable pump drive (motor 2) (MEN2) 53 (1053) : Enable pump drive (motor 3) (MEN3) 54 (1054) : Enable pump drive (motor 4) (MEN4) 87 (1087) : Switch run command 2/1 (FR2/FR1) 88 : Run forward 2 (FWD2) 89 : Run reverse 2 (REV2)	—	—	Y	35
		The codes ranging from 1000 to 1999 in () are the logic reversed signals. Only the code (1009) for [THR] is always a normal logic with "9" being a negative logic.				

*1 When you make settings from the keypad, the incremental unit is restricted by the number of digits that the LED monitor can display.

(Example) If the setting range is from -200.00 to 200.00, the incremental unit is as follows:

"1" for -200 to -100, "0.1" for -99.9 to -10.0, "0.01" for -9.99 to -0.01, "0.01" for 0.00 to 99.99, and "0.1" for 100.0 to 200.0

*2 Symbols used in the data copy column:

Y: Copied

Y1: Not copied if the inverter capacity differs.

Y2: Not copied if the voltage series differs.

N: Not copied

*3 When setting the carrier frequency at 1kHz or below, lower the maximum motor load to 80% of the rated load.

<Changing, setting, and saving data during operation>

□: No data change allowed □: Change with key, and set and save with key. □: Change and set with key, and save with .

● E codes: Extension Terminal Functions

Code	Name	Data setting range	Increment	Unit	Data copying ²	Default setting
E20	Signal Assignment to: (Transistor signal) [Y1] [Y2] [Y3] (Relay contact signal) [Y5A/C] [30A/B/C]	Select a function with the code number from the followings.	—	—	Y	0
E21		0 (1000) : Inverter running (RUN)	—	—	Y	1
E22		1 (1001) : Frequency arrival signal (FAR)	—	—	Y	2
E24		2 (1002) : Frequency detected (FDT)	—	—	Y	15 (10) *1
E27		3 (1003) : Undervoltage detected (Inverter stopped) (LU)	—	—	Y	99
		5 (1005) : Inverter output limiting (IOL)	—	—	Y	
		6 (1006) : Auto-restarting after momentary power failure (IPF)				
		7 (1007) : Motor overload early warning (OL)				
		10 (1010) : Inverter ready to run (RDY)				
		11 : Switch motor drive source between commercial power and inverter output (For MC on commercial line) (SW88)				
		12 : Switch motor drive source between commercial power and inverter output (For primary side) (SW52-2)				
		13 : Switch motor drive source between commercial power and inverter output (For secondary side) (SW52-1)				
		15 (1015) : Select AX terminal function (For MC on primary side) (AX)				
		25 (1025) : Cooling fan in operation (FAN)				
		26 (1026) : Auto-resetting (TRY)				
		27 (1027) : Universal DO (U-DO)				
		28 (1028) : Heat sink overheat early warning (OH)				
		30 (1030) : Service life alarm (LIFE)				
		33 (1033) : Command loss detected (REF OFF)				
		35 (1035) : Inverter output on (RUN2)				
	36 (1036) : Overload prevention control (OLP)					
	37 (1037) : Current detected (ID)					
	42 (1042) : PID alarm (PID-ALM)					
	43 (1043) : Under PID control (PID-CTL)					
	44 (1044) : Motor stopping due to slow flowrate under PID control (PID-STP)					
	45 (1045) : Low output torque detected (U-TL)					
	54 (1054) : Inverter in remote operation (RMT)					
	55 (1055) : Run command activated (AX2)					
	56 (1056) : Motor overheat detected (PTC) (THM)					
	60 (1060) : Mount motor 1, inverter-driven (M1-I)					
	61 (1061) : Mount motor 1, commercial-power-driven (M1-L)					
	62 (1062) : Mount motor 2, inverter-driven (M2-I)					
	63 (1063) : Mount motor 2, commercial-power-driven (M2-L)					
	64 (1064) : Mount motor 3, inverter-driven (M3-I)					
	65 (1065) : Mount motor 3, commercial-power-driven (M3-L)					
	67 (1067) : Mount motor 4, commercial-power-driven (M4-L)					
	68 (1068) : Periodic switching early warning (MCHG)					
	69 (1069) : Pump control limit signal (MLIM)					
	99 (1099) : Alarm output (for any alarm) (ALM)					
	Note: The codes ranging from 1000 to 1999 in () are the logic reversed signals (OFF with short circuit)					
E31	Frequency Detection (FDT) (Detection level)	0.0 to 120.0	0.1	Hz	Y	60.0
E34	Overload Early Warning (Level) /Current Detection (Timer)	0: (Disable)	0.01	A	Y1	100% of the motor rated current
E35		Current value of 1 to 150% of the inverter rated current	0.01	s	Y2	10.00
E40	PID Display Coefficient A	-999 to 0.00 to 999	0.01	—	Y	100
E41	PID Display Coefficient B	-999 to 0.00 to 999	0.01	—	Y	0.00
E43	LED Monitor (Item selection)	0: Speed monitor (Select by E48.) 3: Output current 4: Output voltage 8: Calculated torque 9: Input power 10: PID process command (Final) 12: PID feedback value 14: PID output 15: Load factor 16: Motor output 17: Analog input	—	—	Y	0
E45	LCD Monitor (Item selection)	0: Running status, rotational direction and operation guide 1: Bar charts for output frequency, current and calculated torque	—	—	Y	0
E46	(Language selection)	0: Japanese 1: English 2: German 3: French 4: Spanish 5: Italian	—	—	Y	0
E47	(Contrast control)	0 (Low) to 10 (High)	1	—	Y	5
E48	LED Monitor (Speed monitor item)	0: Output frequency 3: Motor speed in r/min 4: Load shaft speed in r/min 7: Display speed in %	—	—	Y	0
E50	Coefficient for Speed Indication	0.01 to 200.00 *1	0.01	—	Y	30.00
E51	Display Coefficient for Input Watt-hour Data	0.000: (Cancel/reset) 0.001 to 9999	0.001	—	Y	0.010
E52	Keypad (Menu display mode)	0: Function code data editing mode (Menus #0, #1 and #7) 1: Function code data check mode (Menus #2 and #7) 2: Full-menu mode (Menus #0 through #7)	—	—	Y	0



Function Settings

Function Settings

E codes: Extension Terminal Functions

Code	Name	Data setting range	Increment	Unit	Data copying ²	Default setting
E61	Analog Input for (Extension function selection) [12] [C1] [V2]	Select a function with the code number from the followings. 0 : None 1 : Auxiliary frequency command 1 2 : Auxiliary frequency command 2 3 : PID process command 1 5 : PID feedback value 20 : Analog input monitor	—	—	Y	0
E62			—	—	Y	0
E63			—	—	Y	0
E64	Saving Digital Reference Frequency	0 : Auto saving (at the time of main power turned off) 1 : Saving by pressing key	—	—	Y	0
E65	Command Loss Detection (Level)	0 : Decelerate to stop 20 to 120 999: Disable	1	%	Y	999
E80	Detect Low Torque (Detection level)	0 to 150	1	%	Y	20
E81	(Timer)	0.01 to 600.00 *1	0.01	s	Y	20.00
E98	Command Assignment to: [FWD] [REV]	Selecting function code data assigns the corresponding function to terminals [FWD] and [REV] as listed below. Setting the value of 1000s in parentheses () shown below assigns a negative logic input to a terminal. 0 (1000) : Select multistep frequency (Step 0 or 1) (SS1) 1 (1001) : Select multistep frequency (Step 0 or 3) (SS2) 2 (1002) : Select multistep frequency (Step 0 or 7) (SS4) 6 (1006) : Enable 3-wire operation (HLD) 7 (1007) : Coast to a stop (BX) 8 (1008) : Reset alarm (RST) 9 (1009) : Enable external alarm trip (THR) 11 (1011) : Switch frequency command 2/1 (Hz2/Hz1) 13 : Enable DC brake (DCBRK) 15 : Switch to commercial power (50 Hz) (SW50) 16 : Switch to commercial power (60 Hz) (SW60) 17 (1017) : UP command (UP) 18 (1018) : DOWN command (DOWN) 19 (1019) : Enable write from keypad (Data changeable) (WE-KP) 20 (1020) : Cancel PID control (Hz/PID) 21 (1021) : Switch normal/inverse operation (IVS) 22 (1022) : Interlock (IL) 24 (1024) : Enable communications link via RS-485 or field bus (option) (LE) 25 (1025) : Universal DI (U-DI) 26 (1026) : Select starting characteristics (STM) 30 (1030) : Force to stop (STOP) 33 (1033) : Reset PID integral and differential components (PID-RST) 34 (1034) : Hold PID integral component (PID-HLD) 35 (1035) : Select local (keypad) operation (LOC) 38 (1038) : Enable to run (RE) 39 : Protect motor from dew condensation (DWP) 40 : Enable integrated sequence to switch to commercial power (50 Hz) (ISW50) 41 : Enable integrated sequence to switch to commercial power (60 Hz) (ISW60) 50 (1050) : Clear periodic switching time (MCLR) 51 (1051) : Enable pump drive (motor 1) (MEN1) 52 (1052) : Enable pump drive (motor 2) (MEN2) 53 (1053) : Enable pump drive (motor 3) (MEN3) 54 (1054) : Enable pump drive (motor 4) (MEN4) 87 (1087) : Switch run command 2/1 (FR2/FR1) 88 : Run forward 2 (FWD2) 89 : Run reverse 2 (REV2)98: Run forward (FWD) 99 : Run reverse (REV) Note: The codes ranging from 1000 to 1999 in () are the logic reversed signals (OFF with short circuit)	—	—	Y	98
E99			—	—	Y	99

*1 When you make settings from the keypad, the incremental unit is restricted by the number of digits that the LED monitor can display.

(Example) If the setting range is from -200.00 to 200.00, the incremental unit is as follows:

"1" for -200 to -100, "0.1" for -99.9 to -10.0, "0.01" for -9.99 to -0.01, "0.01" for 0.00 to 99.99, and "0.1" for 100.0 to 200.0

*2 Symbols used in the data copy column:

Y: Copied

Y1: Not copied if the inverter capacity differs.

Y2: Not copied if the voltage series differs.

N: Not copied

*3 When setting the carrier frequency at 1kHz or below, lower the maximum motor load to 80% of the rated load.

<Changing, setting, and saving data during operation>

: No data change allowed : Change with key, and set and save with key. : Change and set with key, and save with key.

●C codes: Control Functions of Frequency

Code	Name	Data setting range	Increment	Unit	Data copying ²	Default setting
C01	Jump Frequency 1 2 3	0.0 to 120.0	0.1	Hz	Y	0.0
C02					Y	0.0
C03					Y	0.0
C04	(Band)	0.0 to 30.0	0.1	Hz	Y	0.3
C05	Multistep Frequency 1 2 3 4 5 6 7	0.00 to 120.00	0.01	Hz	Y	0.00
C06					Y	0.00
C07					Y	0.00
C08					Y	0.00
C09					Y	0.00
C10					Y	0.00
C11					Y	0.00
C30	Frequency Command 2	0 : Enable / keys on keypad 1 : Enable voltage input to terminal [12] (0 to 10 VDC) 2 : Enable current input to terminal [C1] (4 to 20 mA DC) 3 : Enable sum of voltage and current inputs to terminals [12] and [C1] 5 : Enable voltage input to terminal [V2] (0 to 10 VDC) 7 : Enable terminal command (UP) / (DOWN) control	—	—	Y	2
C32	Analog Input Adjustment for [12] (Gain)	0.00 to 200.00 *1	0.01	%	Y	100.0
C33	(Filter time constant)	0.00 to 5.00	0.01	s	Y	0.05
C34	(Gain reference point)	0.00 to 100.00 *1	0.01	%	Y	100.0
C37	Analog Input Adjustment for [C1] (Gain)	0.00 to 200.00 *1	0.01	%	Y	100.0
C38	(Filter time constant)	0.00 to 5.00	0.01	s	Y	0.05
C39	(Gain reference point)	0.00 to 100.00 *1	0.01	%	Y	100.0
C42	Analog Input Adjustment for [V2] (Gain)	0.00 to 200.00 *1	0.01	%	Y	100.0
C43	(Filter time constant)	0.00 to 5.00	0.01	s	Y	0.05
C44	(Gain reference point)	0.00 to 100.00 *1	0.01	%	Y	100.0
C50	Bias Reference Point (Frequency command 1)	0.00 to 100.0	0.01	%	Y	0.00
C51	Bias for PID command 1 (Bias value)	-100.0 to 100.00 *1	0.01	%	Y	0.00
C52	(Bias reference point)	0.00 to 100.00 *1	0.01	%	Y	0.00
C53	Selection of Normal/ Inverse Operation (Frequency command 1)	0 : Normal operation 1 : Inverse operation	—	—	Y	0

●P codes: Motor Parameters

Code	Name	Data setting range	Increment	Unit	Data copying ²	Default setting
P01	Motor (No. of poles)	2 to 22	2	Pole	Y1 Y2	4
P02	(Rated capacity)	0.01 to 1000 (where, the data of function code P99 is 0, 3, or 4.) 0.01 to 1000 (where, the data of function code P99 is 1.)	0.01 0.01	kW HP	Y1 Y2	Rated capacity of motor
P03	(Rated current)	0.00 to 2000	0.01	A	Y1Y2	Rated current of Fuji standard motor
P04	(Auto-tuning)	0 : Disable 1 : Enable (Tune %R1 and %X while the motor is stopped.) 2 : Enable (Tune %R1 and %X while the motor is stopped, and no-load current while running.)	—	—	N	0
P05	(No-load current)	0.00 to 2000	0.01	A	Y1Y2	Rated value of Fuji standard motor
P07	(%R1)	0.00 to 50.00	0.01	%	Y1Y2	Rated value of Fuji standard motor
P08	(%X)	0.00 to 50.00	0.01	%	Y1Y2	Rated value of Fuji standard motor
P99	Motor Selection	0 : Characteristics of motor 0 (Fuji standard motors, 8-series and 9-series) 1 : Characteristics of motor 1 (HP-rated motors) 3 : Characteristics of motor 3 (Fuji standard motors, 6-series and 9-series) 4 : Other motors	—	—	Y1Y2	0

●H codes: High Performance Functions

Code	Name	Data setting range	Increment	Unit	Data copying	Default setting
H03	Data Initialization	0 : Disable initialization 1 : Initialize all function code data to the factory defaults 2 : Initialize motor parameters	—	—	N	0
H04	Auto-resetting (Times)	0 : Disable 1 to 10	1	Times	Y	0
H05	(Reset interval)	0.5 to 20.0	0.1	s	Y	5.0
H06	Cooling Fan ON/OFF Control	0 : Disable (Always in operation) 1 : Enable (ON/OFF controllable)	—	—	Y	0
H07	Acceleration/Deceleration Pattern	0 : Linear 1 : S-curve (Weak) 2 : S-curve (Strong) 3 : Curvilinear	—	—	Y	0
H09	Select Starting Characteristics (Auto search for idling motor speed)	0 : Disable 3 : Enable (Follow Run command, either forward or reverse.) 4 : Enable (Follow Run command, both forward and reverse.) 5 : Enable (Follow Run command, inversely both forward and reverse.)	—	—	Y	0
H11	Deceleration Mode	0 : Normal deceleration 1 : Coast-to-stop	—	—	Y	0
H12	Instantaneous Overcurrent Limiting (Mode selection)	0 : Disable 1 : Enable	—	—	Y	1



Function Settings

Function Settings

●H codes: High Performance Functions

Code	Name	Data setting range	Increment	Unit	Data copying ^{*2}	Default setting																				
H13	Restart Mode after Momentary Power Failure (Restart time)	0.1 to 10.0	0.1	s	Y	Depend-ing on the inverter capacity																				
H14	(Frequency fall rate)	0.00 : Set deceleration time 0.01 to 100.00 999 : Follow the current limit command	0.01	Hz/s	Y	999																				
H15	(Continuous running level)	200V series: 200 to 300 400V series: 400 to 600	1	V	Y2	235 470																				
H16	(Allowable momentary power failure time)	0.0 to 30.0 999: The longest time automatically determined by the inverter	0.1	s	Y	999																				
H17	Select Starting Characteristics (Frequency for idling motor speed)	0.0 to 120.0 999: Harmonize at the maximum frequency	0.1	Hz	Y	999																				
H26	PTC Thermistor (Mode selection)	0 : Disable 1 : Enable (Upon detection of (PTC), the inverter immediately trips and stops with OH4 displayed.) 2 : Enable (Upon detection of (PTC), the inverter continues running while outputting alarm signal (THM).)	—	—	Y	0																				
H27	(Level)	0.00 to 5.00	0.01	V	Y	1.60																				
H30	Communications Link Function (Mode selection)	Frequency command 0 : F01/C30 1 : RS485 link 2 : F01/C30 3 : RS485 link 4 : RS485 link (Option) 5 : RS485 link (Option) 6 : F01/C30 7 : RS485 link 8 : RS485 link (Option) Run command F02 F02 RS485 link RS485 link F02 RS485 link RS485 link (Option) RS485 link (Option) RS485 link (Option)	—	—	Y	0																				
H42	Capacitance of DC Link Bus Capacitor	Indication for replacing DC link bus capacitor (0000 to FFFF: Hexadecimal)	—	—	N	—																				
H43	Cumulative Run Time of Cooling Fan	Indication of cumulative run time of cooling fan for replacement	—	—	N	—																				
H47	Initial Capacitance of DC Link Bus Capacitor	Indication for replacing DC link bus capacitor (0000 to FFFF: Hexadecimal)	—	—	N	Set at factory shipping																				
H48	Cumulative Run Time of Capacitors on the Printed Circuit Board	Indication for replacing capacitors on printed circuit board (0000 to FFFF: Hexadecimal). Resettable.	—	—	N	—																				
H49	Select Starting Characteristics (Auto search time for idling motor speed)	0.0 to 10.0	0.1	s	Y	0.0																				
H50	Non-linear V/f Pattern (Frequency)	0.0 : Cancel 0.1 to 120.0	0.1	Hz	Y	0.0 (22 kW or below) 30 (30 kW or above)																				
H51	(Voltage)	0 to 240: Output a voltage AVR-controlled (for 200 V series) 0 to 500: Output a voltage AVR-controlled (for 400 V series)	1	V	Y2	0 (22 kW or below) 20 (30 kW or above for 200V series) 40 (30 kW or above for 400V series)																				
H56	Deceleration Time for Forced Stop	0.00 to 3600	0.01	s	Y	20.0																				
H63	Low Limiter (Mode selection)	0 : Limit by F16 (Frequency Limiter: Low) and continue to run 1 : If the output frequency lowers less than the one limited by F16 (Frequency Limiter: Low), decelerates to stop the motor.	—	—	Y	0																				
H64	(Lower limiting frequency)	0.0 (Depends on F16 (Frequency Limiter: Low)) 0.1 to 60.0	0.1	Hz	Y	2.0																				
H69	Automatic Deceleration (Mode selection)	0 : Disable 3 : Enable (Control DC link bus voltage at a constant.)	—	—	Y	0																				
H70	Overload Prevention Control (Frequency drop rate)	0.00: Follow deceleration time specified by F08 0.01 to 100.00 999: Disable	0.01	Hz/s	Y	999																				
H71	Deceleration Characteristics	0 : Disable 1 : Enable	—	—	Y	0																				
H80	Gain for Suppression of Output Current Fluctuation for Motor	0.00 to 0.40	0.01	—	Y	Depend-ing on the inverter capacity																				
H86	Reserved. *2	0 to 2	1	—	Y1 Y2	*4 Depend-ing on the inverter capacity																				
H87	Reserved. *2	25.0 to 120.0	0.1	Hz	Y	25.0																				
H88	Reserved. *2	0 to 3, 999	1	—	N	0																				
H89	Reserved. *2	0, 1	—	—	Y	0																				
H90	Reserved. *2	0, 1	—	—	Y	0																				
H91	Reserved. *2	0, 1	—	—	Y	0																				
H92	Continue to Run (P-component: gain)	0.000 to 10.000 *1	0.001	Times	Y	999																				
H93	(I-component: time)	0.010 to 10.000 *1	0.001	s	Y	999																				
H94	Cumulative Run Time of Motor	Change or reset the cumulative data	—	—	N	-																				
H95	DC Braking (Braking response mode)	0 : Slow 1 : Quick	—	—	Y	1																				
H96	STOP Key Priority/ Start Check Function	<table border="1"> <thead> <tr> <th>Item</th> <th colspan="4">Data</th> </tr> <tr> <th></th> <th>0</th> <th>1</th> <th>2</th> <th>3</th> </tr> </thead> <tbody> <tr> <td>STOP key priority</td> <td>Disable</td> <td>Enable</td> <td>Disable</td> <td>Enable</td> </tr> <tr> <td>Start check function</td> <td>Disable</td> <td>Disable</td> <td>Enable</td> <td>Enable</td> </tr> </tbody> </table>	Item	Data					0	1	2	3	STOP key priority	Disable	Enable	Disable	Enable	Start check function	Disable	Disable	Enable	Enable	—	—	Y	0
Item	Data																									
	0	1	2	3																						
STOP key priority	Disable	Enable	Disable	Enable																						
Start check function	Disable	Disable	Enable	Enable																						
H97	Clear Alarm Data	Setting H97 data to "1" clears alarm data and then returns to zero.	—	—	N	0																				
H98	Protection/ Maintenance Function	0 to 63: Display data on the keypad's LED monitor in decimal format (In each bit, "0" for disabled, "1" for enabled.) Bit 0 : Lower the carrier frequency automatically Bit 1 : Detect input phase loss Bit 2 : Detect output phase loss Bit 3 : Select life judgment criteria of DC link bus capacitor Bit 4 : Judge the life of DC link bus capacitor Bit 5 : Detect DC fan lock	—	—	Y	19 (Bits 4, 1, 0 = 1)																				

*2 The H86 through H91 are displayed, but they are reserved for particular manufacturers. Unless otherwise specified, do not access these function codes.

● J codes: Application Functions

Code	Name	Data setting range	Increment	Unit	Data copying ²	Default setting
J01	PID Control (Mode selection)	0 : Disable 1 : Enable (normal operation) 2 : Enable (inverse operation)	—	—	Y	0
J02	(Remote process command)	0 : Enable / keys on keypad 1 : PID process command 1 3 : Enable terminal command (UP) / (DOWN) control 4 : Command via communications link	—	—	Y	0
J03	P (Gain)	0.000 to 30.000 *1	0.001	Times	Y	0.100
J04	I (Integral time)	0.0 to 3600.0 *1	0.1	s	Y	0.0
J05	D (Differential time)	0.00 to 600.00 *1	0.01	s	Y	0.00
J06	(Feedback filter)	0.0 to 900.0	0.1	s	Y	0.5
J10	(Anti reset windup)	0 to 200	1	%	Y	200
J11	(Select alarm output)	0 : Absolute-value alarm 1 : Absolute-value alarm (with Hold) 2 : Absolute-value alarm (with Latch) 3 : Absolute-value alarm (with Hold and Latch) 4 : Deviation alarm 5 : Deviation alarm (with Hold) 6 : Deviation alarm (with Latch) 7 : Deviation alarm (with Hold and Latch)	—	—	Y	0
J12	(Upper limit alarm (AH))	0 to 100	1	%	Y	100
J13	(Lower limit alarm (AL))	0 to 100	1	%	Y	0
J15	(Stop frequency for slow flowrate)	0 : Disable 1 to 120	1	Hz	Y	0
J16	(Slow flowrate level stop latency)	1 to 60	1	s	Y	30
J17	(Starting frequency)	0 : Disable 1 to 120	1	Hz	Y	0
J18	(Upper limit of PID process output)	1 to 120 999: Depends on setting of F15	1	Hz	Y	999
J19	(Lower limit of PID process output)	1 to 120 999: Depends on setting of F16	1	Hz	Y	999
J21	Dew Condensation Prevention (Duty)	1 to 50	1	%	Y	1
J22	Commercial Power Switching Sequence	0 : Keep inverter operation (Stop due to alarm) 1 : Automatically switch to commercial-power operation	—	—	Y	0

● y codes: Link Functions

Code	Name	Data setting range	Increment	Unit	Data copying ²	Default setting
y01	RS485 Communication (Station address)	1 to 255	1	—	Y	1
y02	(Communications error processing)	0 : Immediately trip and alarm <i>E-r-B</i> 1 : Trip and alarm <i>E-r-B</i> after running for the period specified by timer y03 2 : Retry during the period specified by timer y03. If retry fails, trip and alarm <i>E-r-B</i> . If it succeeds, continue to run. 3 : Continue to run	—	—	Y	0
y03	(Error processing timer)	0.0 to 60.0	0.1	s	Y	2.0
y04	(Transmission speed)	0 : 2400 bps 1 : 4800 bps 2 : 9600 bps 3 : 19200 bps 4 : 38400 bps	—	—	Y	3
y05	(Data length)	0 : 8 bits 1 : 7 bits	—	—	Y	0
y06	(Parity check)	0 : None 1 : Even parity 2 : Odd parity	—	—	Y	0
y07	(Stop bits)	0 : 2 bits 1 : 1 bit	—	—	Y	0
y08	(No-response error detection time)	0 (No detection), 1 to 60	1	s	Y	0
y09	(Response latency time)	0.00 to 1.00	0.01	s	Y	0.01
y10	(Protocol selection)	0 : Modbus RTU protocol 1 : FRENIC Loader protocol (SX protocol) 2 : Fuji general-purpose inverter protocol	—	—	Y	1

*1 When you make settings from the keypad, the incremental unit is restricted by the number of digits that the LED monitor can display.

(Example) If the setting range is from -200.00 to 200.00, the incremental unit is as follows:

"1" for -200 to -100, "0.1" for -99.9 to -10.0, "0.01" for -9.99 to -0.01, "0.01" for 0.00 to 99.99, and "0.1" for 100.0 to 200.0

*2 Symbols used in the data copy column:

Y: Copied

Y1: Not copied if the inverter capacity differs.

Y2: Not copied if the voltage series differs.

N: Not copied

*3 When setting the carrier frequency at 1kHz or below, lower the maximum motor load to 80% of the rated load.

<Changing, setting, and saving data during operation>

: No data change allowed : Change with key, and set and save with key. : Change and set with key, and save with .



Function Settings

Function Settings

Codes: Link Functions

Code	Name	Data setting range	Increment	Unit	Data copying ²	Default setting	
y11	RS-485 Communication 2 (Station address)	1 to 255	1	—	Y	1	
y12	(Communications error processing)	0 : Immediately trip and alarm <i>Er-P</i> 1 : Trip and alarm <i>Er-P</i> after running for the period specified by timer y13. 2 : Retry during the period specified by timer y13. If retry fails, trip and alarm <i>Er-P</i> . If it succeeds, continue to run. 3 : Continue to run.	—	—	Y	0	
y13	(Error processing timer)	0.0 to 60.0	0.1	s	Y	2.0	
y14	(Transmission speed)	0 : 2400 bps 1 : 4800 bps 2 : 9600 bps 3 : 19200 bps 4 : 38400 bps	—	—	Y	3	
y15	(Data length)	0 : 8 bits 1 : 7 bits	—	—	Y	0	
y16	(Parity check)	0 : None 1 : Even parity 2 : Odd parity	—	—	Y	0	
y17	(Stop bits)	0 : 2 bits 1 : 1 bit	—	—	Y	0	
y18	(No-response error detection time)	0 : (No detection), 1 to 60	1	s	Y	0	
y19	(Response latency time)	0.00 to 1.00	0.01	s	Y	0.01	
y20	(Protocol selection)	0 : Modbus RTU protocol 2 : Fuji general-purpose inverter protocol	—	—	Y	0	
y98	Bus Link Function (Mode selection)	Frequency command	—	—	Y	0	
		Run command					
		0: Follow H30 data					Follow H30 data
		1: Via field bus option					Follow H30 data
y99	Loader Link Function (Mode selection)	Frequency command	—	—	N	0	
		Run command					
		0: Follow H30 and y98 data					Follow H30 and y98 data
		1: Via RS-485 link (Loader)					Follow H30 and y98 data
2: Follow H30 and y98 data	Via RS-485 link (Loader)						
3: Via RS-485 link (Loader)	Via RS-485 link (Loader)						

*1 When you make settings from the keypad, the incremental unit is restricted by the number of digits that the LED monitor can display.

(Example) If the setting range is from -200.00 to 200.00, the incremental unit is as follows:

"1" for -200 to -100, "0.1" for -99.9 to -10.0, "0.01" for -9.99 to -0.01, "0.01" for 0.00 to 99.99, and "0.1" for 100.0 to 200.0

*2 Symbols used in the data copy column:

Y: Copied

Y1: Not copied if the inverter capacity differs.

Y2: Not copied if the voltage series differs.

N: Not copied

*3 When setting the carrier frequency at 1kHz or below, lower the maximum motor load to 80% of the rated load.

<Changing, setting, and saving data during operation>

: No data change allowed : Change with key, and set and save with key. : Change and set with key, and save with key.

Peripheral Equipment Connection Diagrams

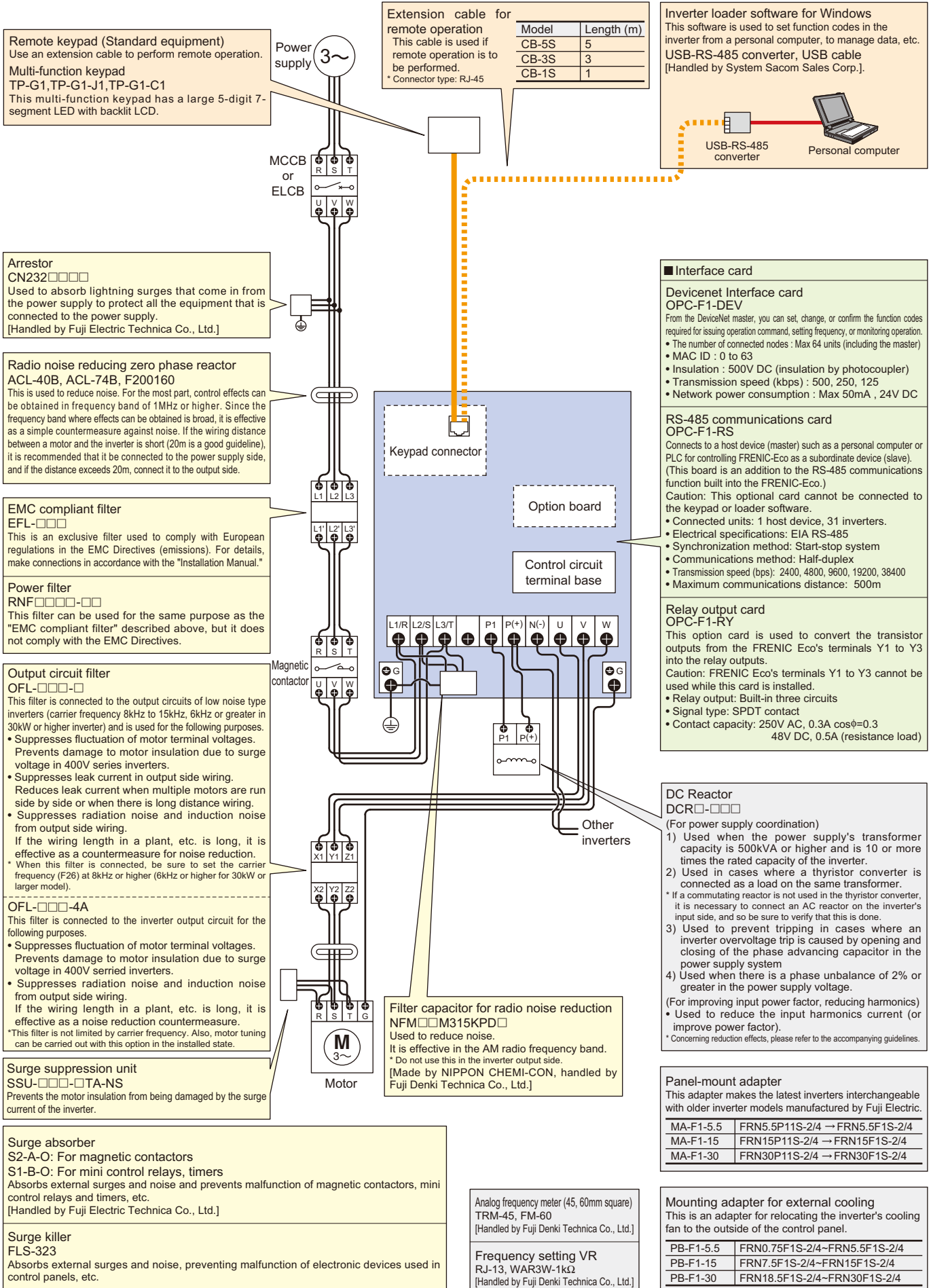



Options

DC REACTOR

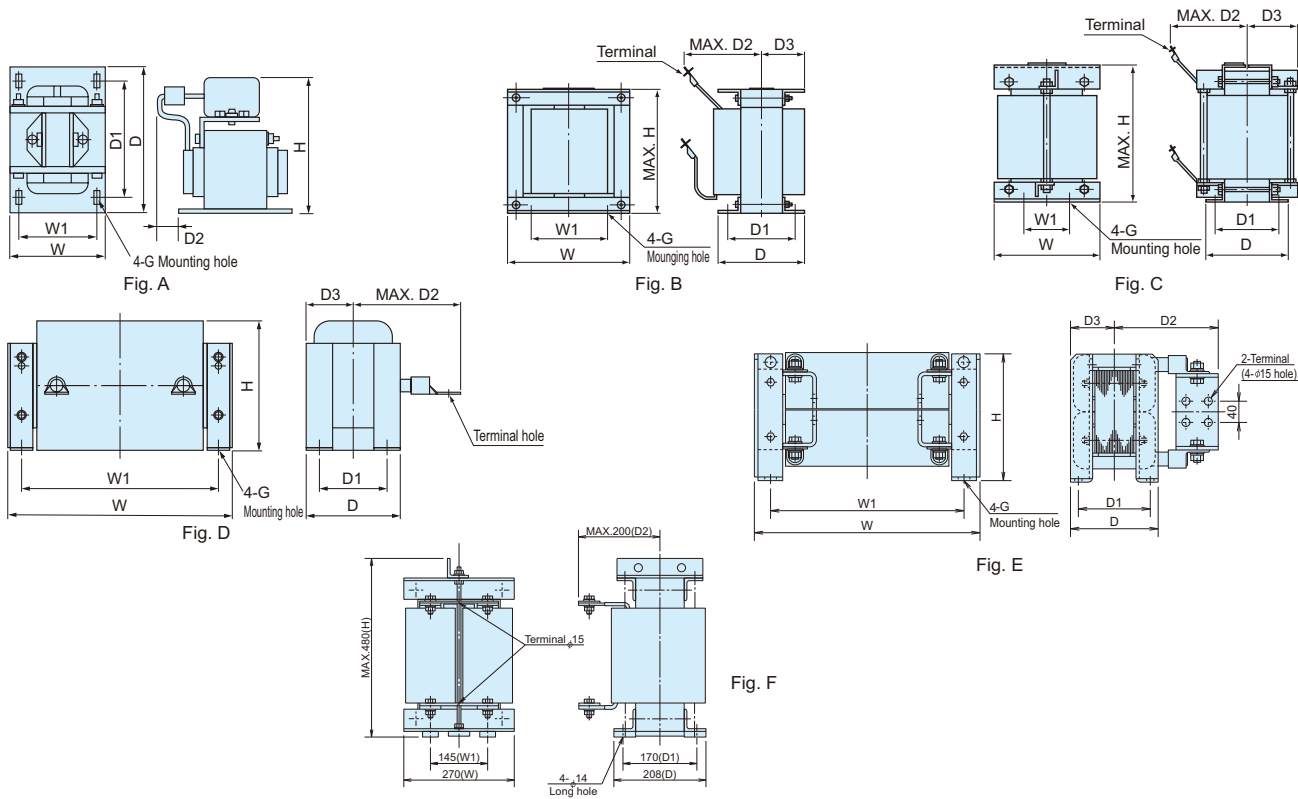

Power supply voltage	Applicable motor rating (kW)	Inverter type	REACTOR type	Fig.	Dimension (mm)								Mass (kg)	
					W	W1	D	D1	D2	D3	H	Mounting hole		Terminal hole
3-phase 200V	0.75	FRN0.75F1□-2A	DCR2-0.75	A	66	56	90	72	20	—	94	5.2 x 8	M4	1.4
	1.5	FRN1.5F1□-2A	DCR2-1.5	A	66	56	90	72	20	—	94	5.2 x 8	M4	1.6
	2.2	FRN2.2F1□-2A	DCR2-2.2	A	86	71	100	80	10	—	110	6 x 11	M4	1.8
	3.7	FRN3.7F1□-2A	DCR2-3.7	A	86	71	100	80	20	—	110	6 x 11	M4	2.6
	5.5	FRN5.5F1□-2A	DCR2-5.5	A	111	95	100	80	20	—	130	7 x 11	M5	3.6
	7.5	FRN7.5F1□-2A	DCR2-7.5	A	111	95	100	80	23	—	130	7 x 11	M5	3.8
	11	FRN11F1□-2A	DCR2-11	A	111	95	100	80	24	—	137	7 x 11	M6	4.3
	15	FRN15F1□-2A	DCR2-15	A	146	124	120	96	15	—	180	7 x 11	M6	5.9
	18.5	FRN18.5F1□-2A	DCR2-18.5	A	146	124	120	96	25	—	180	7 x 11	M8	7.4
	22	FRN22F1□-2A	DCR2-22A	A	146	124	120	96	25	—	180	7 x 11	M8	7.5
	30	FRN30F1□-2A	DCR2-30B	B	152±3	90±1	156±3	116±2	115	78±5	130	8	M8	12
	37	FRN37F1□-2A	DCR2-37B	B	171±3	110±1	151±3	110±2	115	75±5	150	8	M8	14
	45	FRN45F1□-2A	DCR2-45B	B	171±3	110±1	166±3	125±2	120	86±5	150	8	M10	16
	55	FRN55F1□-2A	DCR2-55B	C	190±3	160±1	131±3	90±2	100	65±5	210	8	M12	16
3-phase 400V	75	FRN75F1□-2A	DCR2-75C	D	255±10	225	106±2	86±1	145	53±1	145	6	M12	11.4
	90	FRN90F1□-2A	DCR2-90C	D	255±10	225	116±2	96	155	58±1	145	M6	M12	14
	110	FRN110F1□-2A	DCR2-110C	D	300±10	265	116±4	90	185	58±2	160	M8	M12	17
	0.75	FRN0.75F1□-4A	DCR4-0.75	A	66	56	90	72	20	—	94	5.2 x 8	M4	1.4
	1.5	FRN1.5F1□-4A	DCR4-1.5	A	66	56	90	72	20	—	94	5.2 x 8	M4	1.6
	2.2	FRN2.2F1□-4A	DCR4-2.2	A	86	71	100	80	15	—	110	6 x 9	M4	2
	3.7	FRN3.7F1□-4A	DCR4-3.7	A	86	71	100	80	20	—	110	6 x 9	M4	2.6
	5.5	FRN5.5F1□-4A	DCR4-5.5	A	86	71	100	80	20	—	110	6 x 9	M4	2.6
	7.5	FRN7.5F1□-4A	DCR4-7.5	A	111	95	100	80	24	—	130	7 x 11	M5	4.2
	11	FRN11F1□-4A	DCR4-11	A	111	95	100	80	24	—	130	7 x 11	M5	4.3
	15	FRN15F1□-4A	DCR4-15	A	146	124	120	96	15	—	171	7 x 11	M5	5.9
	18.5	FRN18.5F1□-4A	DCR4-18.5	A	146	124	120	96	25	—	171	7 x 11	M6	7.2
	22	FRN22F1□-4A	DCR4-22A	A	146	124	120	96	25	—	171	7 x 11	M6	7.2
	30	FRN30F1□-4A	DCR4-30B	B	152±3	90±1	157±3	115±2	100	78±5	130	8	M8	13
37	FRN37F1□-4A	DCR4-37B	B	171±3	110±1	150±3	110±2	100	75±5	150	8	M8	15	
45	FRN45F1□-4A	DCR4-45B	B	171±3	110±1	165±3	125±2	110	82±5	150	8	M8	18	
55	FRN55F1□-4A	DCR4-55B	B	171±3	110±1	170±3	130±2	110	85±5	150	8	M8	20	
75	FRN75F1□-4A	DCR4-75C	D	255±10	225	106±2	86±1	125	53±1	145	6	M10	12.4	
90	FRN90F1□-4A	DCR4-90C	D	256±10	225	116±2	96±1	130	58±1	145	6	M12	14.7	
110	FRN110F1□-4A	DCR4-110C	D	306±10	265	116±4	90±2	140	58±2	155	8	M12	18.4	
132	FRN132F1□-4A	DCR4-132C	D	306±10	265	126±4	100±2	150	63±2	160	8	M12	22	
160	FRN160F1□-4A	DCR4-160C	D	357±10	310	131±4	103±2	160	65.5±2	190	10	M12	25.5	
200	FRN200F1□-4A	DCR4-200C	D	357±10	310	141±4	113±2	165	70.5±2	190	10	M12	29.5	
220	FRN220F1□-4A	DCR4-220C	D	357±10	310	146±4	118±2	185	73±2	190	10	M12	32.5	
280	FRN280F1□-4A	DCR4-280C	D	350±10	310	161±4	133	210	80.5±2	190	M10	M16	36	
315	FRN315F1□-4A	DCR4-315C	D	400±10	345	146±4	118	200	73±2	225	M10	M16	40	
355	FRN355F1□-4A	DCR4-355C	E	400±10	345	156±4	128±2	200	78±2	225	M10	—	47	
400	FRN400F1□-4A	DCR4-400C	E	445±10	385	145±4	117	213	72.5±2	245	M10	—	62	
450	FRN450F1□-4A	DCR4-450C	E	440±10	385	150±4	122±2	215	75±2	245	M10	—	50	
500	FRN500F1□-4A	DCR4-500C	E	445±10	390	165±4	137±2	220	82.5±2	245	M10	—	70	
560	FRN560F1□-4A	DCR4-560C	F	270	145	208	170	200	—	480	φ14 long hole	φ15	70	

Note: Substitute "□" in the inverter model number with an alphabetic letter.

- S (Standard type)
- E (EMC filter built-in type)
- H (DC REACTOR built-in type)
- L or D (Waterproof type)

●Interface card

DeviceNet interface card (OPC-F1-DEV)

Use this interface card to enter or monitor operation commands or frequency or to change or check the settings of function codes necessary for operation at the master station of DeviceNet.

- Number of connectable nodes: Max. 64 (including the master)
- MAC ID: 0 to 63
- Insulation: 500V DC (by photocoupler)
- Transmission speed: 500kbps/250kbps/125kbps
- Network power consumption: Max. 50mA at 24V DC

RS-485 communications card (OPC-F1-RS)

Connect this card with a host (master) device such as a PC or PLC when you want to use FRENIC-Eco as a subordinate device (slave). (The card is added to RS-485 communications port built in FRENIC-Eco.)

Note: This option card cannot be connected to a keypad or a PC loader.

- Number of connectable devices: 31 inverters connected to one host
- Electric specification: EIA RS-485
- Synchronization method: Start/stop
- Communication method: Half-duplex
- Transmission speed (bps): 2400, 4800, 9600, 19200 and 38400
- Maximum communication distance: 500m

Relay output card (OPC-F1-RY)

Use this option card to convert the transistor outputs issued from the terminals Y1 to Y3 of the main body of FRENIC-Eco into relay outputs. Note: FRENIC-Eco's terminals Y1 to Y3 cannot be used while this card is installed.

- Relay outputs: Built-in three circuits
- Contact: SPDT contact
- Contact capacity: 250V AC, 0.3A cosφ=0.3
48V DC, 0.5A (resistance load)

CC-Link card (OPC-F1-CCL)

By connecting this card with a CC-Link master unit, the baud rate can be extended up to 10Mbps and the total transmission distance up to 1200m.

- Number of connectable devices: Max. 42
- Communication method: CC-Link ver. 1.10 and 2.0
- Transmission speed: 156kbps or more

PROFIBUS card (OPC-F1-PDP)

With this interface card, you can do the following operations from the PROFIBUS-DP master: issuing the inverter operation command, issuing the frequency command, monitoring the operating status, and changing the settings in all the function codes of FRENIC-Eco.

- Transmission speed: 9.6kbps to 12Mbps
- Transmission distance: Max. 1200m
- Connector: 6-pole terminal base

LonWORKS interface card (OPC-F1-LNW)

With use of this interface card, the peripheral devices (including a master) linked through LonWORKS can be connected to FRENIC-Eco. This allows you to issue an operation command or a frequency setting command from the master.

- No. of network variables: 62
- No. of connectable devices: 24
- Transmission speed: 78kbps

●Mounting adapter for external cooling (PB-F1-□□□)

Use this adapter to shift the heat sink to the outside of the control panel. For 37kW or larger inverters, the head sink can be extended, without using this adapter, by simply relocating the mounting base.

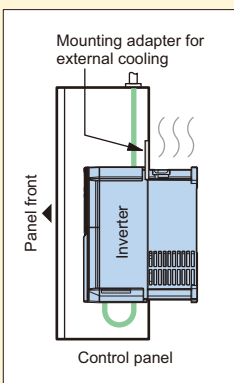

Optional type	Applicable inverter type
PB-F1-5.5	FRN0.75F1 *-2A
	FRN1.5F1 *-2A
	FRN2.2F1 *-2A
	FRN3.7F1 *-2A
	FRN5.5F1 *-2A
	FRN0.75F1 *-4A
	FRN1.5F1 *-4A
	FRN2.2F1 *-4A
	FRN3.7F1 *-4A
	FRN5.5F1 *-4A
PB-F1-15	FRN7.5F1 *-2A
	FRN11F1 *-2A
	FRN15F1 *-2A
	FRN7.5F1 *-4A
	FRN11F1 *-4A
PB-F1-30	FRN18.5F1 *-2A
	FRN22F1 *-2A
	FRN30F1 *-2A
	FRN18.5F1 *-4A
	FRN22F1 *-4A
	FRN30F1 *-4A
	FRN30F1 *-4A

●Multi-function keypad (TP-G1,TP-G1-J1,TP-G1-C1)

Versatile keypad equipped with an LCD panel

[Unit: mm]

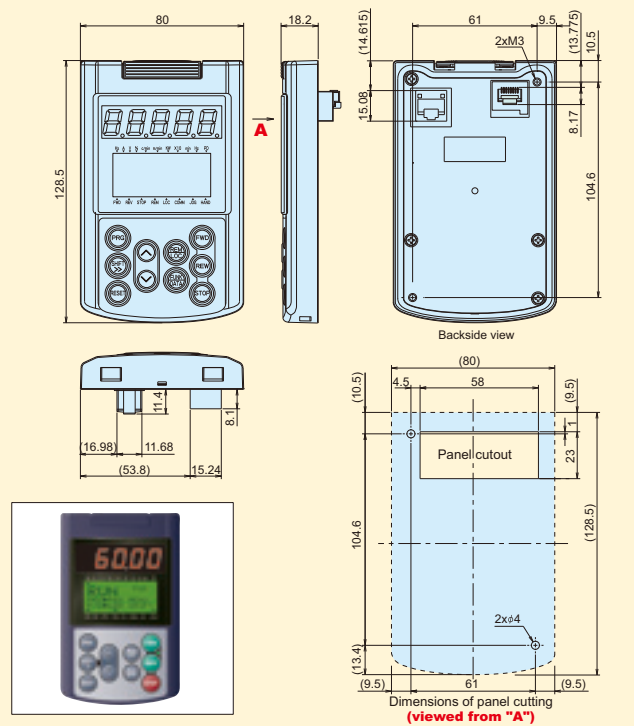

●Extension cable for remote operation (CB-□S)

This straight cable is used to connect the inverter and the remote keypad.

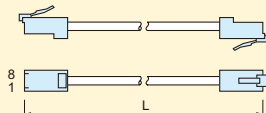

Connector type: RJ-45

Optional type	Length (m)
CB-5S	5
CB-3S	3
CB-1S	1

●Panel-mount adapter (MA-F1-□□□)

Use this adapter when installing the FRENIC-Eco by using the mounting hole of the already installed inverter (FRENIC5000P11S, 5.5 to 37kW).

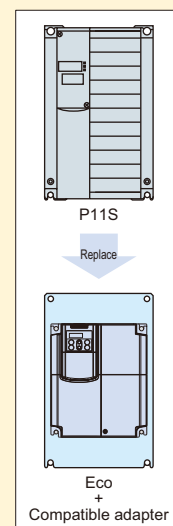

Optional type	Applicable inverter type	Already installed inverter type
MA-F1-5.5	FRN0.75F1S-2A	FRN5.5P11S-2
	FRN1.5F1S-2A	FRN7.5P11S-2
	FRN2.2F1S-2A	FRN11P11S-2
	FRN3.7F1S-2A	FRN5.5P11S-4
	FRN5.5F1S-2A	FRN7.5P11S-4
	FRN0.75F1S-4A	FRN11P11S-4
	FRN1.5F1S-4A	
	FRN2.2F1S-4A	
	FRN3.7F1S-4A	
	FRN5.5F1S-4A	
MA-F1-15	FRN7.5F1S-2A	FRN15P11S-2
	FRN11F1S-2A	FRN18.5P11S-2
	FRN15F1S-2A	FRN22P11S-2
	FRN7.5F1S-4A	FRN15P11S-4
	FRN11F1S-4A	FRN18.5P11S-4
MA-F1-30	FRN15F1S-4A	FRN22P11S-4
	FRN18.5F1S-2A	FRN30P11S-2
	FRN22F1S-2A	FRN37P11S-2
	FRN30F1S-2A	FRN30P11S-4
	FRN18.5F1S-4A	FRN37P11S-4
	FRN22F1S-4A	
	FRN30F1S-4A	

Note: The * mark in the applicable inverter type stands for any of the following alphabets.
* S (standard type), H (DCR built-in type), E (EMC filter built-in type)

Guideline for Suppressing Harmonics

Application to "Guideline for Suppressing Harmonics by the Users Who Receive High Voltage or Special High Voltage"

Our FRENIC-Multi series are the products specified in the "Guideline for Suppressing Harmonics by Customers Receiving High Voltage or Special High Voltage." When you enter into a new contract with an electric power company or update a contract, you are requested by the electric power company to submit an accounting statement form.

(1) Scope of regulation

- In principle, the guideline applies to the customers that meet the following two conditions:
 - The customer receives high voltage or special high voltage.
 - The "equivalent capacity" of the converter load exceeds the standard value for the receiving voltage (50kVA at a receiving voltage of 6.6kV).

(2) Regulation method

The level (calculated value) of the harmonic current that flows from the customer's receiving point out to the system is subjected to the regulation. The regulation value is proportional to the contract demand. The regulation values specified in the guideline are shown in Table 1.

Table 1 Upper limits of harmonic outflow current per kW of contract demand [mA/kW]

Receiving voltage	5th	7th	11th	13th	17th	19th	23th	Over 25th
6.6kV	3.5	2.5	1.6	1.3	1.0	0.90	0.76	0.70
22kV	1.8	1.3	0.82	0.69	0.53	0.47	0.39	0.36

1. Calculation of Equivalent Capacity (Pi)

Although the equivalent capacity (Pi) is calculated using the equation of (input rated capacity) x (conversion factor), catalog of conventional inverters do not contain input rated capacities. A description of the input rated capacity is shown below:

(1) "Inverter rated capacity" corresponding to "Pi"

- Calculate the input fundamental current I1 from the kW rating and efficiency of the load motor, as well as the efficiency of the inverter. Then, calculate the input rated capacity as shown below:
 Input rated capacity = $\sqrt{3} \times (\text{power supply voltage}) \times I_1 \times 1.0228/1000[\text{kVA}]$
 Where 1.0228 is the 6-pulse converter's value obtained by (effective current) / (fundamental current).
- When a general-purpose motor or inverter motor is used, the appropriate value shown in Table 2 can be used. Select a value based on the kW rating of the motor used, irrespective of the inverter type.

Table 2 "Input rated capacities" of general-purpose inverters determined by the nominal applied motors

Nominal applied motor [kW]	0.4	0.75	1.5	2.2	3.7	5.5	7.5	11	15	18.5	22	
Pi [kVA]	200V	0.57	0.97	1.95	2.81	4.61	6.77	9.07	13.1	17.6	21.8	25.9
	400V	0.57	0.97	1.95	2.81	4.61	6.77	9.07	13.1	17.6	21.8	25.9
Nominal applied motor [kW]	30	37	45	55	75	90	110	132	160	200	220	
Pi [kVA]	200V	34.7	42.8	52.1	63.7	87.2	104	127				
	400V	34.7	42.8	52.1	63.7	87.2	104	127	153	183	229	252
Nominal applied motor [kW]	250	280	315	355	400	450	500	530	560	630		
Pi [kVA]	200V											
	400V	286	319	359	405	456	512	570	604	638	718	

(2) Values of "Ki (conversion factor)"

- Depending on whether an optional ACR (AC REACTOR) or DCR (DC REACTOR) is used, apply the appropriate conversion factor specified in the appendix to the guideline. The values of the converter factor are shown in Table 3.

Table 3 "Conversion factors Ki" for general-purpose inverters determined by reactors

Circuit category	Circuit type	Conversion factor Ki	Main applications	
3	Three-phase bridge 3 (capacitor smoothing)	Without a reactor	K31=3.4	<ul style="list-style-type: none"> General-purpose inverters Elevators Refrigerators, air conditioning systems Other general appliances
		With a reactor (ACR)	K32=1.8	
		With a reactor (DCR)	K33=1.8	
		With reactors (ACR and DCR)	K34=1.4	

2. Calculation of Harmonic Current

(1) Value of "input fundamental current"

- Apply the appropriate value shown in Table 4 based on the kW rating of the motor, irrespective of the inverter type or whether a reactor is used.
- * If the input voltage is different, calculate the input fundamental current in inverse proportion to the voltage.

Table 4 "Input fundamental currents" of general-purpose inverters determined by the nominal applied motors

Nominal applied motor [kW]	0.4	0.75	1.5	2.2	3.7	5.5	7.5	11	15	18.5	22	
Input fundamental current [A]	200V	1.62	2.74	5.50	7.92	13.0	19.1	25.6	36.9	49.8	61.4	73.1
	400V	0.81	1.37	2.75	3.96	6.50	9.55	12.8	18.5	24.9	30.7	36.6
6.6 kV converted value [mA]		49	83	167	240	394	579	776	1121	1509	1860	2220
Nominal applied motor [kW]	30	37	45	55	75	90	110	132	160	200	220	
Input fundamental current [A]	200V	98.0	121	147	180	245	293	357				
	400V	49.0	60.4	73.5	89.9	123	147	179	216	258	323	355
6.6 kV converted value [mA]		2970	3660	4450	5450	7450	8910	10850	13090	15640	19580	21500
Nominal applied motor [kW]	250	280	315	355	400	450	500	530	560	630		
Input fundamental current [A]	200V											
	400V	403	450	506	571	643	723	804	852	900	1013	
6.6 kV converted value [mA]		24400	27300	30700	34600	39000	43800	48700	51600	54500	61400	

(2) Calculation of harmonic current

Table 5 Generated harmonic current [%], 3-phase bridge (capacitor smoothing)

Degree	5th	7th	11th	13th	17th	19th	23th	25th
Without a reactor	65	41	8.5	7.7	4.3	3.1	2.6	1.8
With a reactor (ACR)	38	14.5	7.4	3.4	3.2	1.9	1.7	1.3
With a reactor (DCR)	30	13	8.4	5.0	4.7	3.2	3.0	2.2
With reactors (ACR and DCR)	28	9.1	7.2	4.1	3.2	2.4	1.6	1.4

- ACR: 3%
 - DCR: Accumulated energy equal to 0.08 to 0.15ms (100% load conversion)
 - Smoothing capacitor: Accumulated energy equal to 15 to 30ms (100% load conversion)
 - Load: 100%
- nth harmonic current [A] = Fundamental current [A] x $\frac{\text{Generated nth harmonic current} [\%]}{100}$

Calculate the harmonic current of each degree using the following equation:

(3) Maximum availability factor

- For a load for elevators, which provides intermittent operation, or a load with a sufficient designed motor rating, reduce the current by multiplying the equation by the "maximum availability factor" of the load.
- The "maximum availability factor of an appliance" means the ratio of the capacity of the harmonic generator in operation at which the availability reaches the maximum, to its total capacity, and the capacity of the generator in operation is an average for 30 minutes.
- In general, the maximum availability factor is calculated according to this definition, but the standard values shown in Table 6 are recommended for inverters for building equipment.

Table 6 Availability factors of inverters, etc. for building equipment (standard values)

Equipment type	Inverter capacity category	Single inverter availability factor
Air conditioning system	200kW or less	0.55
	Over 200kW	0.60
Sanitary pump	—	0.30
Elevator	—	0.25
Refrigerator, freezer	50kW or less	0.60
UPS (6-pulse)	200kVA	0.60

[Correction coefficient according to contract demand level]

- Since the total availability factor decreases with increase in the building scale, calculating reduced harmonics with the correction coefficient s defined in Table 7 below is permitted.

Table 7 Correction coefficient according to the building scale

Contract demand [kW]	Correction coefficient β
300	1.00
500	0.90
1000	0.85
2000	0.80

*If the contract demand is between two specified values shown in Table 7, calculate the value by interpolation.

(4) Degree of harmonics to be calculated

Calculate only the "5th and 7th" harmonic currents

3. Others

"Guideline for Suppressing Harmonics in Home Electric and General-purpose Appliances" (established in September 1994 and revised in October 1999) issued by the Ministry of Economy, Trade and Industry was admonished on September 2004. Therefore, the "Guideline for Suppressing Harmonics by Customers Receiving High Voltage or Special High Voltage" will be applied in the future. We, as before, recommend that you connect a reactor (for suppressing harmonics) to your inverter. As a reactor, select a "DC REACTOR" introduced in this catalog. For use of the other reactor, please inquire of us about detailed specifications.



Warranty

To all our customers who purchase Fuji Electric products included in this catalog:

Please take the following items into consideration when placing your order.

When requesting an estimate and placing your orders for the products included in these materials, please be aware that any items such as specifications which are not specifically mentioned in the contract, catalog, specifications or other materials will be as mentioned below.

In addition, the products included in these materials are limited in the use they are put to and the place where they can be used, etc., and may require periodic inspection. Please confirm these points with your sales representative or directly with this company.

Furthermore, regarding purchased products and delivered products, we request that you take adequate consideration of the necessity of rapid receiving inspections and of product management and maintenance even before receiving your products.

1. Free of Charge Warranty Period and Warranty Range

1-1 Free of charge warranty period

- (1) The product warranty period is "1 year from the date of purchase" or 24 months from the manufacturing date imprinted on the name plate, whichever date is earlier.
- (2) However, in cases where the use environment, conditions of use, use frequency and times used, etc., have an effect on product life, this warranty period may not apply.
- (3) Furthermore, the warranty period for parts restored by Fuji Electric's Service Department is "6 months from the date that repairs are completed."

1-2 Warranty range

- (1) In the event that breakdown occurs during the product's warranty period which is the responsibility of Fuji Electric, Fuji Electric will replace or repair the part of the product that has broken down free of charge at the place where the product was purchased or where it was delivered. However, if the following cases are applicable, the terms of this warranty may not apply.
 - 1) The breakdown was caused by inappropriate conditions, environment, handling or use methods, etc. which are not specified in the catalog, operation manual, specifications or other relevant documents.
 - 2) The breakdown was caused by the product other than the purchased or delivered Fuji's product.
 - 3) The breakdown was caused by the product other than Fuji's product, such as the customer's equipment or software design, etc.
 - 4) Concerning the Fuji's programmable products, the breakdown was caused by a program other than a program supplied by this company, or the results from using such a program.
 - 5) The breakdown was caused by modifications or repairs affected by a party other than Fuji Electric.
 - 6) The breakdown was caused by improper maintenance or replacement using consumables, etc. specified in the operation manual or catalog, etc.
 - 7) The breakdown was caused by a chemical or technical problem that was not foreseen when making practical application of the product at the time it was purchased or delivered.
 - 8) The product was not used in the manner the product was originally intended to be used.
 - 9) The breakdown was caused by a reason which is not this company's responsibility, such as lightning or other disaster.
- (2) Furthermore, the warranty specified herein shall be limited to the purchased or delivered product alone.
- (3) The upper limit for the warranty range shall be as specified in item (1) above and any damages (damage to or loss of machinery or equipment, or lost profits from the same, etc.) consequent to or resulting from breakdown of the purchased or delivered product shall be excluded from coverage by this warranty.

1-3. Trouble diagnosis

As a rule, the customer is requested to carry out a preliminary trouble diagnosis. However, at the customer's request, this company or its service network can perform the trouble diagnosis on a chargeable basis. In this case, the customer is asked to assume the burden for charges levied in accordance with this company's fee schedule.

2. Exclusion of Liability for Loss of Opportunity, etc.

Regardless of whether a breakdown occurs during or after the free of charge warranty period, this company shall not be liable for any loss of opportunity, loss of profits, or damages arising from special circumstances, secondary damages, accident compensation to another company, or damages to products other than this company's products, whether foreseen or not by this company, which this company is not be responsible for causing.

3. Repair Period after Production Stop, Spare Parts Supply Period (Holding Period)

Concerning models (products) which have gone out of production, this company will perform repairs for a period of 7 years after production stop, counting from the month and year when the production stop occurs. In addition, we will continue to supply the spare parts required for repairs for a period of 7 years, counting from the month and year when the production stop occurs. However, if it is estimated that the life cycle of certain electronic and other parts is short and it will be difficult to procure or produce those parts, there may be cases where it is difficult to provide repairs or supply spare parts even within this 7-year period. For details, please confirm at our company's business office or our service office.

4. Transfer Rights

In the case of standard products which do not include settings or adjustments in an application program, the products shall be transported to and transferred to the customer and this company shall not be responsible for local adjustments or trial operation.

5. Service Contents

The cost of purchased and delivered products does not include the cost of dispatching engineers or service costs. Depending on the request, these can be discussed separately.

Variation

●The rich lineup of the active Fuji inverter family

Applications	Series Name (Catalog No.)	Features
General Industrial equipment	<p>NEW</p> <p>FRENIC-MEGA (MEH642 for JE) (MEH655 for EN)</p>	<p>High-performance, multi-functional inverter (Three-phase 400V: 0.4 to 630kW, Three-phase 200V: 0.4 to 90kW)</p> <ul style="list-style-type: none"> ● Loaded with vector control which is the peak of general purpose inverters. ● Prepared three types; the basic type, EMC filter built-in type. ● Maintainability is further improved with built-in USB port(option). ● The short-time acceleration and deceleration become enabled with achieving better rating of overload ratings at HD spec: 200% for 3 sec and 150% for 1 min and at LD spec: 120% for 1 min.
	<p>FRENIC5000G11S (MEH403 for JE) (MEH413 for EN)</p>	<p>High-performance, multi-functional inverter multi-functional Capacity range expanded (Three-phase 200V: 0.2 to 90kW, Three-phase 400V: 0.4 to 630kW)</p> <ul style="list-style-type: none"> ● Fuji's original dynamic torque vector control system delivers a starting torque of 200% at 0.5Hz. ● These inverters are packed with a full range of convenient functions, beginning with an auto tuning function. ● Compact, fully enclosed (22kW and below).
	<p>FRENIC5000P11S (MEH403)</p>	<p>Fan, pump inverter Capacity range expanded (Three-phase 200V: 5.5 to 110kW, Three-phase 400V: 5.5 to 710kW)</p> <ul style="list-style-type: none"> ● Suitable for fans and pumps. ● The built-in automatic energy-saving function makes energy saving operation easy. ● An interactive keypad is standard-equipped for ease of operation.
	<p>FRENIC-Multi (MEH652 for JE) (MEH653 for EN)</p>	<p>High performance, compact inverter (Three-phase 200V: 0.1 to 15kW, Single-phase 200V: 0.1 to 2.2kW, Three-phase 400V: 0.4 to 15kW)</p> <ul style="list-style-type: none"> ● The inverter featuring environment-friendly and long life design (10 years) complies with RoHS Directives (products manufactured beginning in the autumn of 2005). ● With expanded capacity range, abundant model variation, and simple and thorough maintenance, the Multi is usable for a wide range of applications. ● Equipped with the functions optimum for the operations specific to vertical and horizontal conveyance, such as hit-and-stop control, brake signal, torque limit, and current limit.
	<p>FRENIC-Eco (MEH442)</p>	<p>Fan, pump inverter (for variable torque load) (Three-phase 200V: 0.75 to 110kW, Three-phase 400V: 0.75 to 560kW)</p> <ul style="list-style-type: none"> ● Developed exclusively for controlling variable torque load like fans and pumps. ● Full of new functions such as auto energy saving, PID control, life warning, and switching sequence to the commercial power supply. ● Ideal for air conditioners, fans, pumps, etc. which were difficult to use with conventional general-purpose inverters because of cost or functions.
	<p>FRENIC-Mini (MEH441 for JE) (MEH451 for EN)</p>	<p>Compact inverter (Three-phase 200V: 0.1 to 3.7kW, Three-phase 400V: 0.4 to 3.7kW, Single-phase 200V: 0.1 to 2.2kW, Single-phase 100V: 0.1 to 0.75kW)</p> <ul style="list-style-type: none"> ● A frequency setting device is standard-equipped, making operation simple. ● Loaded with auto torque boost, current limiting, and slip compensation functions, all of which are ideal for controlling traverse conveyors. ● Loaded with the functions for auto energy saving operation and PID control, which are ideal for controlling fans and pumps.
	<p>FRENIC5000VG7S (MEH405)</p>	<p>High performance, vector control inverter Capacity range expanded (Three-phase 200V: 0.75 to 90kW, Three-phase 400V: 3.7 to 800kW)</p> <ul style="list-style-type: none"> ● A high precision inverter with rapid control response and stable torque characteristics. ● Abundant functions and a full range of options make this inverter ideal for a broad range of general industrial systems. ● The auto tuning function makes vector control operation possible even for general-purpose motors.



Safety Precautions

1. Use the contents of this catalog only for selecting product types and models. When using a product, read the Instruction Manual beforehand to use the product correctly.
2. Products introduced in this catalog have not been designed or manufactured for such applications in a system or equipment that will affect human bodies or lives. Customers, who want to use the products introduced in this catalog for special systems or devices such as for atomic-energy control, aerospace use, medical use, and traffic control, are requested to consult the Fuji's Sales Division. Customers are requested to prepare safety measures when they apply the products introduced in this catalog to such systems or facilities that will affect human lives or cause severe damage to property if the products become faulty.



NOTES

When running general-purpose motors

- **Driving a 400V general-purpose motor**
When driving a 400V general-purpose motor with an inverter using extremely long cables, damage to the insulation of the motor may occur. Use an output circuit filter (OFL) if necessary after checking with the motor manufacturer. Fuji's motors do not require the use of output circuit filters because of their reinforced insulation.
- **Torque characteristics and temperature rise**
When the inverter is used to run a general-purpose motor, the temperature of the motor becomes higher than when it is operated using a commercial power supply. In the low-speed range, the cooling effect will be weakened, so decrease the output torque of the motor. If constant torque is required in the low-speed range, use a Fuji inverter motor or a motor equipped with an externally powered ventilating fan.
- **Vibration**
When the motor is mounted to a machine, resonance may be caused by the natural frequencies, including that of the machine. Operation of a 2-pole motor at 60Hz or more may cause abnormal vibration.
 - * Study use of tier coupling or dampening rubber.
 - * It is also recommended to use the inverter jump frequency control to avoid resonance points.
- **Noise**
When an inverter is used with a general-purpose motor, the motor noise level is higher than that with a commercial power supply. To reduce noise, raise carrier frequency of the inverter. High-speed operation at 60Hz or more can also result in more noise.

When running special motors

- **High-speed motors**
When driving a high-speed motor while setting the frequency higher than 120Hz, test the combination with another motor to confirm the safety of high-speed motors.
- **Explosion-proof motors**
When driving an explosion-proof motor with an inverter, use a combination of a motor and an inverter that has been approved in advance.
- **Submersible motors and pumps**
These motors have a larger rated current than general-purpose motors. Select an inverter whose rated output current is greater than that of the motor.
These motors differ from general-purpose motors in thermal characteristics. Set a low value in the thermal time constant of the motor when setting the electronic thermal facility.
- **Brake motors**
For motors equipped with parallel-connected brakes, their braking power must be supplied from the primary circuit (commercial power supply). If the brake power is connected to the inverter power output circuit (secondary circuit) by mistake, problems may occur.
Do not use inverters for driving motors equipped with series-connected brakes.
- **Geared motors**
If the power transmission mechanism uses an oil-

lubricated gearbox or speed changer/reducer, then continuous motor operation at low speed may cause poor lubrication. Avoid such operation.

- **Synchronous motors**
It is necessary to use software suitable for this motor type. Contact Fuji for details.
- **Single-phase motors**
Single-phase motors are not suitable for inverter-driven variable speed operation. Use three-phase motors.
 - * Even if a single-phase power supply is available, use a three-phase motor as the inverter provides three-phase output.

Environmental conditions

- **Installation location**
Use the inverter in a location with an ambient temperature range of -10 to 50°C.
The inverter and braking resistor surfaces become hot under certain operating conditions. Install the inverter on nonflammable material such as metal. Ensure that the installation location meets the environmental conditions specified in "Environment" in inverter specifications.

Combination with peripheral devices

- **Installing a molded case circuit breaker (MCCB)**
Install a recommended molded case circuit breaker (MCCB) or an earth leakage circuit breaker (ELCB) in the primary circuit of each inverter to protect the wiring. Ensure that the circuit breaker capacity is equivalent to or lower than the recommended capacity.
- **Installing a magnetic contactor (MC) in the output (secondary) circuit**
If a magnetic contactor (MC) is mounted in the inverter's secondary circuit for switching the motor to commercial power or for any other purpose, ensure that both the inverter and the motor are fully stopped before you turn the MC on or off. Remove the surge killer integrated with the MC.
- **Installing a magnetic contactor (MC) in the input (primary) circuit**
Do not turn the magnetic contactor (MC) in the primary circuit on or off more than once an hour as an inverter fault may result. If frequent starts or stops are required during motor operation, use FWD/REV signals.
- **Protecting the motor**
The electronic thermal facility of the inverter can protect the motor. The operation level and the motor type (general-purpose motor, inverter motor) should be set. For high-speed motors or water-cooled motors, set a small value for the thermal time constant to protect the motor.
If you connect the motor thermal relay to the motor with a long cable, a high-frequency current may flow into the wiring stray capacitance. This may cause the relay to trip at a current lower than the set value for the thermal relay. If this happens, lower the carrier frequency or use the output circuit filter (OFL).
- **Discontinuance of power-factor correcting capacitor**
Do not mount power factor correcting capacitors in the inverter (primary) circuit. (Use the DC REACTOR to improve the inverter power factor.) Do

not use power factor correcting capacitors in the inverter output circuit (secondary). An overcurrent trip will occur, disabling motor operation.

- **Discontinuance of surge killer**
Do not mount surge killers in the inverter output (secondary) circuit.
- **Reducing noise**
Use of a filter and shielded wires are typical measures against noise to ensure that EMC Directives are met.
- **Measures against surge currents**
If an overvoltage trip occurs while the inverter is stopped or operated under a light load, it is assumed that the surge current is generated by open/close of the phase-advancing capacitor in the power system.
We recommend connecting a DC REACTOR to the inverter.
- **Megger test**
When checking the insulation resistance of the inverter, use a 500V megger and follow the instructions contained in the Instruction Manual.

Wiring

- **Wiring distance of control circuit**
When performing remote operation, use the twisted shield wire and limit the distance between the inverter and the control box to 20m.
- **Wiring length between inverter and motor**
If long wiring is used between the inverter and the motor, the inverter will overheat or trip as a result of overcurrent (high-frequency current flowing into the stray capacitance) in the wires connected to the phases. Ensure that the wiring is shorter than 50m. If this length must be exceeded, lower the carrier frequency or mount an output circuit filter (OFL).
- **Wiring size**
Select cables with a sufficient capacity by referring to the current value or recommended wire size.
- **Wiring type**
Do not use multicore cables that are normally used for connecting several inverters and motors.
- **Grounding**
Securely ground the inverter using the grounding terminal.

Selecting inverter capacity

- **Driving general-purpose motor**
Select an inverter according to the applicable motor ratings listed in the standard specifications table for the inverter. When high starting torque is required or quick acceleration or deceleration is required, select an inverter with a capacity one size greater than the standard.
- **Driving special motors**
Select an inverter that meets the following condition:
Inverter rated current > Motor rated current.

Transportation and storage

When transporting or storing inverters, follow the procedures and select locations that meet the environmental conditions that agree with the inverter specifications.

Fuji Electric Systems Co., Ltd.

Mitsui Sumitomo Bank Ningyo-cho Bldg.,
5-7, Nihonbashi Odemma-cho, Chuo-ku, Tokyo 103-0011, Japan
Phone: +81-3-5847-8011 Fax: +81-3-5847-8172

Printed on recycled paper

Information in this catalog is subject to change without notice.

Printed in Japan 2008-9 (C08d/L03) CM 30 FIS